

# DCS Thyristor Power Converters for DC Drive Systems 25 to 5200 A

## System Description DCS 600 MultiDrive

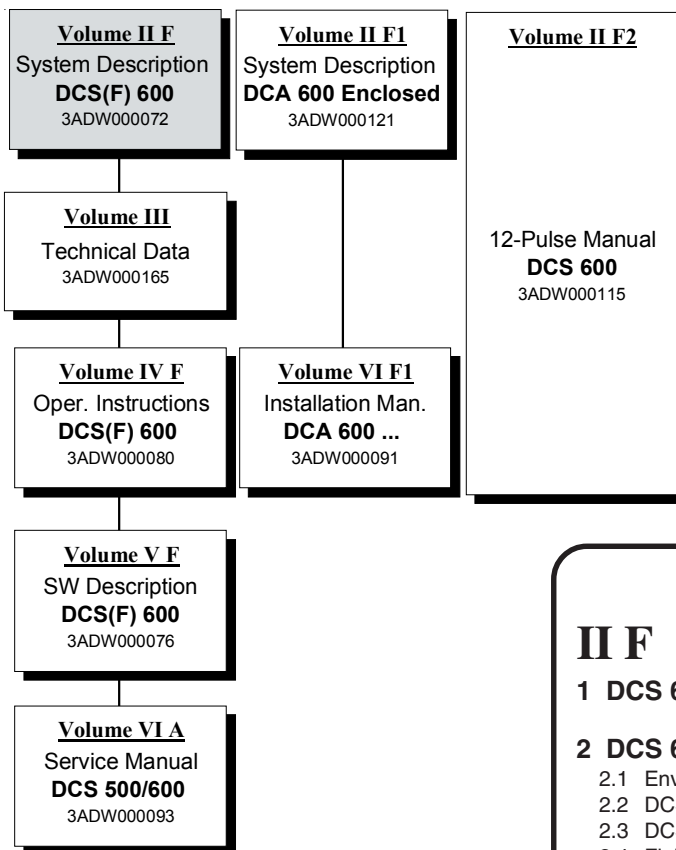



## How the DCS 600 MultiDrive Documentation System works

This is to give you an overview how the system of information for DCS 600 MultiDrive converters is built up. The shaded part indicates the volume within the total system you are just now working with. In addition you see all other available documents for the same system.

## List of contents

### II F SYSTEM DESCRIPTION

<b>1 DCS 600 MultiDrive - the power converter</b>	<b>II F 1-1</b>
<b>2 DCS 600 MultiDrive components overview</b>	<b>II F 2-1</b>
2.1 Environmental conditions .....	II F 2-3
2.2 DCS 600 power converter modules .....	II F 2-4
2.3 DCS 600 overload withstand capability .....	II F 2-7
2.4 Field Supply .....	II F 2-9
2.5 Options for power converter modules .....	II F 2-11
In-/output signals .....	II F 2-11
Serial interfaces	
Operation by the panel .....	II F 2-13
Panel (control and display panel) .....	II F 2-14
Operation by the PC .....	II F 2-15
Drive control .....	II F 2-15
2.6 Options .....	II F 2-17
Line reactors for armature (DCS600) and	
field (DCF600) supply .....	II F 2-17
Aspects of fusing for armature circuits and field	
supplies of DC drives .....	II F 2-19
Semiconductor type F1 fuses and fuse holders for	
AC and DC power lines .....	II F 2-21
Fuses F3.x fuses and fuse holders for 2-phase	
field supply .....	II F 2-21
Transformer T3 for field supply .....	II F 2-22
Commutating reactor .....	II F 2-22
Auxiliary transformer T2 for electronic system /	
fan supply .....	II F 2-22
Residual current detection .....	II F 2-22
EMC filters .....	II F 2-23
<b>3 Overview of Software (Vers. 15.xxx) .....</b>	<b>II F 3-1</b>
3.1 Basic structure of DCS 600 MultiDrive .....	II F 3-1
3.2 Control modes .....	II F 3-1
3.3 Start, Stop and Fault reactions .....	II F 3-2
3.5 Torque control .....	II F 3-4
3.4 Speed control .....	II F 3-4
3.5 Torque control .....	II F 3-4
3.6 HMI (Human Machine Interface) .....	II F 3-4
3.7 Torque generation .....	II F 3-5
3.7 Software diagrams .....	II F 3-6
<b>4 Connection examples .....</b>	<b>II F 4-1</b>

# 1 DCS 600 MultiDrive - the power converter

- ❖ state-of-the-art technology
- ❖ flexible design
- ❖ user-friendly

ABB's long years of experience with variable-speed DC drives, plus use of the latest state-of-the-art technologies, have been combined to create this product. The DCS 600 MultiDrive contains a complete program with ratings between 25 A and 5200 A as a power converter module (in 12-pulse parallel configuration appr. 10,000 A). It is suitable for all commonly used three-phase systems.



All our products are CE approved.

**DIN EN ISO 9001**

**DIN EN ISO 14001**



The DC drives factory of ABB Automation Products, Drives Division in Lampertheim has implemented and maintains a quality management system according to DIN EN ISO 9001 and an environmental management system according to DIN EN ISO 14001.

DCS 600 MultiDrives are approved according to UL (Underwriters Laboratory).



They also comply with the relevant EMC standards for Australia and New Zealand and are C-Tick marked.

DCS 600 MultiDrive converter units are suitable for standard and system drive applications.

Appropriate PC programs ensure that the drives are engineered for user-friendly operator control.

## Unit range

The range comprises of 5 sizes, C1, C2, A5, A6 and A7. We can deliver both modules and standard cubicles.

## Basic hardware components

- \* Thyristor bridge(s) (from size A5 with installed branch fuses)
- \* Temperature monitor for the thyristor bridge(s)
- \* Fan
- \* Integrated power supply for the electronics
- \* Microprocessor board
- \* AMC (Application Motor Control) board with DSP (Digital Signal Processor) for drive control and DDCS link

## Additional components integrated in the module

- \* Field supply converter
  - uncontrolled full wave diode bridge, 6A or
  - half-controlled diode/thyristor bridge, 16A
- \* Control panel

Moreover, the accessories listed below can be used to individually customize the drive package in accordance with the application intended

- \* External field supply units
- \* 12-Pulse parallel configuration
- \* 12-Pulse serial/sequential configuration
- \* Additional I/O boards (isolated)
- \* Interface modules for various communication protocols
- \* EMC filter
- \* PC programs



C1 - Module

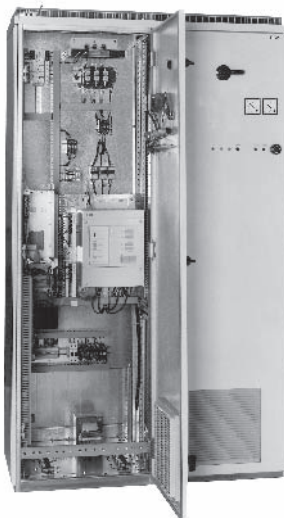

DCA cubicle

## Basic functions

All units are provided with the same digital control boards and software. The DCS 600 MultiDrive flexibility allows the user to configure functions of the drive easily, suitable for different applications. Functions of the DCS 600 MultiDrive are normally activated by parameters.

### The basic software includes the following options:

- Processing the speed reference with a speed ramp generator (S-ramp capability, accel/decel ramp)
- Processing the speed feedback
- Speed controller
- Torque reference processing
- Current controller
- Field weakening
- Automatic/manual field reversal
- Autotuning of current controller
- Speed monitor
- Drive control logic
- Remote/local operation
- Emergency stop
- Electronic circuits are not sensitive to line phase sequence
- Electrical and mechanical brake control
- Motor overload supervision
- Dual field
- Programmable analogue outputs
- Field supply
- Master follower via fibre optics
- 12-pulse link

## Controlling and operating

via I/O's

analogue and digital inputs and outputs

via bus systems

e.g.: Profibus, Modbus Plus, AF100 etc.

via HMI (Human Machine Interface)

Outputs:

- Alarms
- Faults
- Status information
- Parameter setting
- Local control of the drive

## Design and commissioning tools

### DriveWindow

PC program for commissioning and maintenance under Windows® for:

- Parameter setting
- Fault detection
- Trending
- Data logger
- Fault logger
- Local operation (Drives Panel)

CDP 312 removable control and display panel with plain text display for:

- Drive control signal
- Parameter setting
- Fault detection
- Parameter uploading and downloading
- Local operation

## Monitoring functions

### Self-test

### Fault logger

### Motor protection

In the event of:

- Speed feedback error
- Overtemperature
- Overload
- Overspeed
- Zero speed
- Armature overcurrent
- Armature ripple
- Armature overvoltage
- Minimum field current
- Field overcurrent
- Motor stalled

### Power converter protection

- Overtemperature
- Software errors (watchdog function)

### Incorrect supply protection

- Mains overvoltage and undervoltage
- Auxiliary undervoltage
- Incorrect mains phase sequence (only inform.)

# 2 DCS 600 MultiDrive Components Overview

## DCS 600 Armature converter

The DCS 600 MultiDrive power converter range is a system of components and complete standard cabinets to control DC motors. It consists of individual components, based on the DCS 600 power converter modules. This

chapter provides a brief description of the DCS 600 MultiDrive components available for matching the drive with the conditions on site.

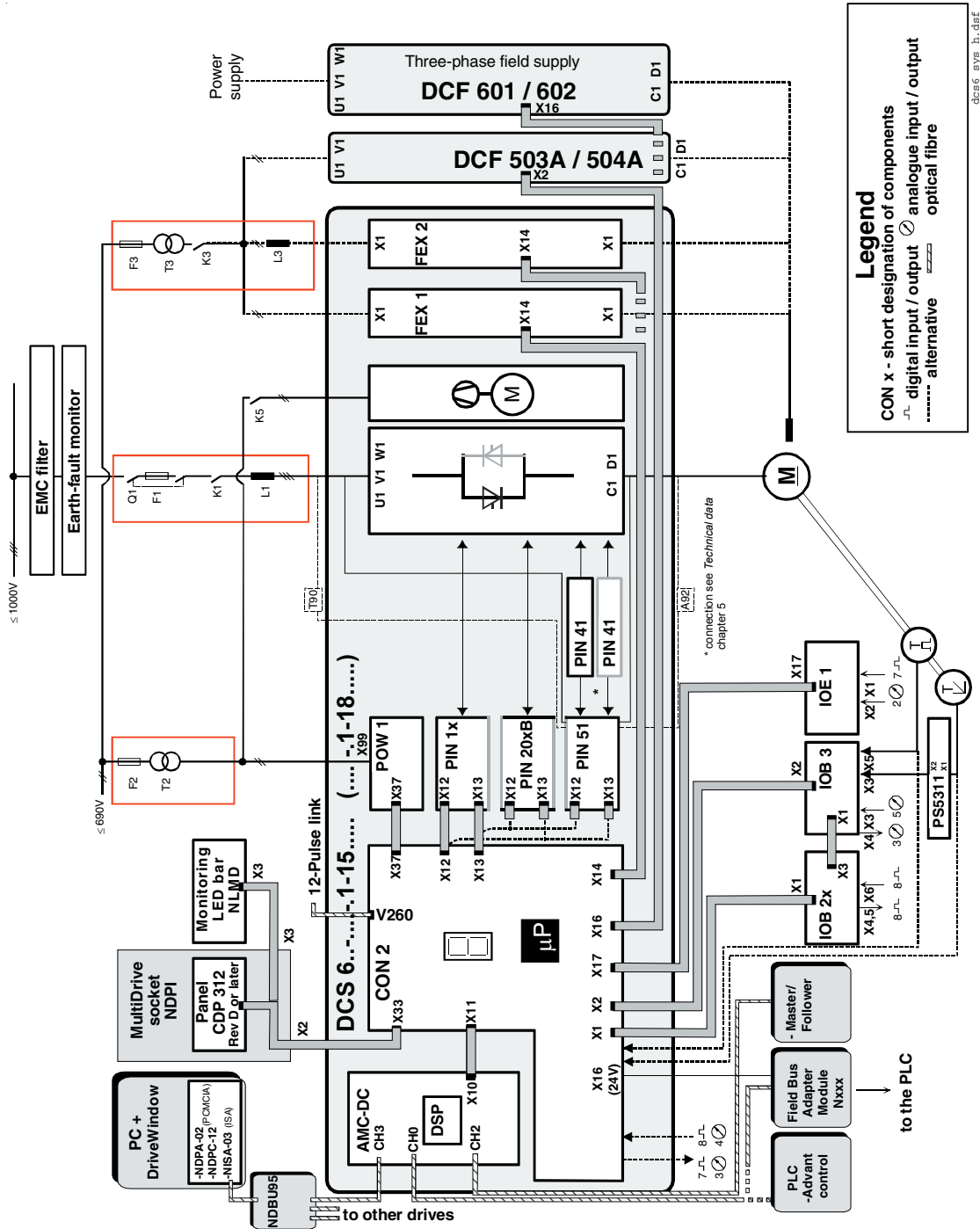

Fig. 2/1: DCS 600 MultiDrive Components overview for armature converters

This overview has been designed to help you to familiarize yourself with the system; its main components are shown in the diagram above. The system's heart is the DCS 600 converter module.

## DCF 600 Field supply converter

The DCF 600 field supply converter range is a system of components and complete standard cabinets to control the field supply of DC motors. It consists of individual components, based on the DCS 600 power converter modules. The difference to the armature converter is only

the modified power interface board SDCS-PIN-1x (if used) and the reduced range of current and voltage types (see table 2.2/2). The function for field supply will be selected by software parameters.

**Note:** Armature and field converters use the same firmware.

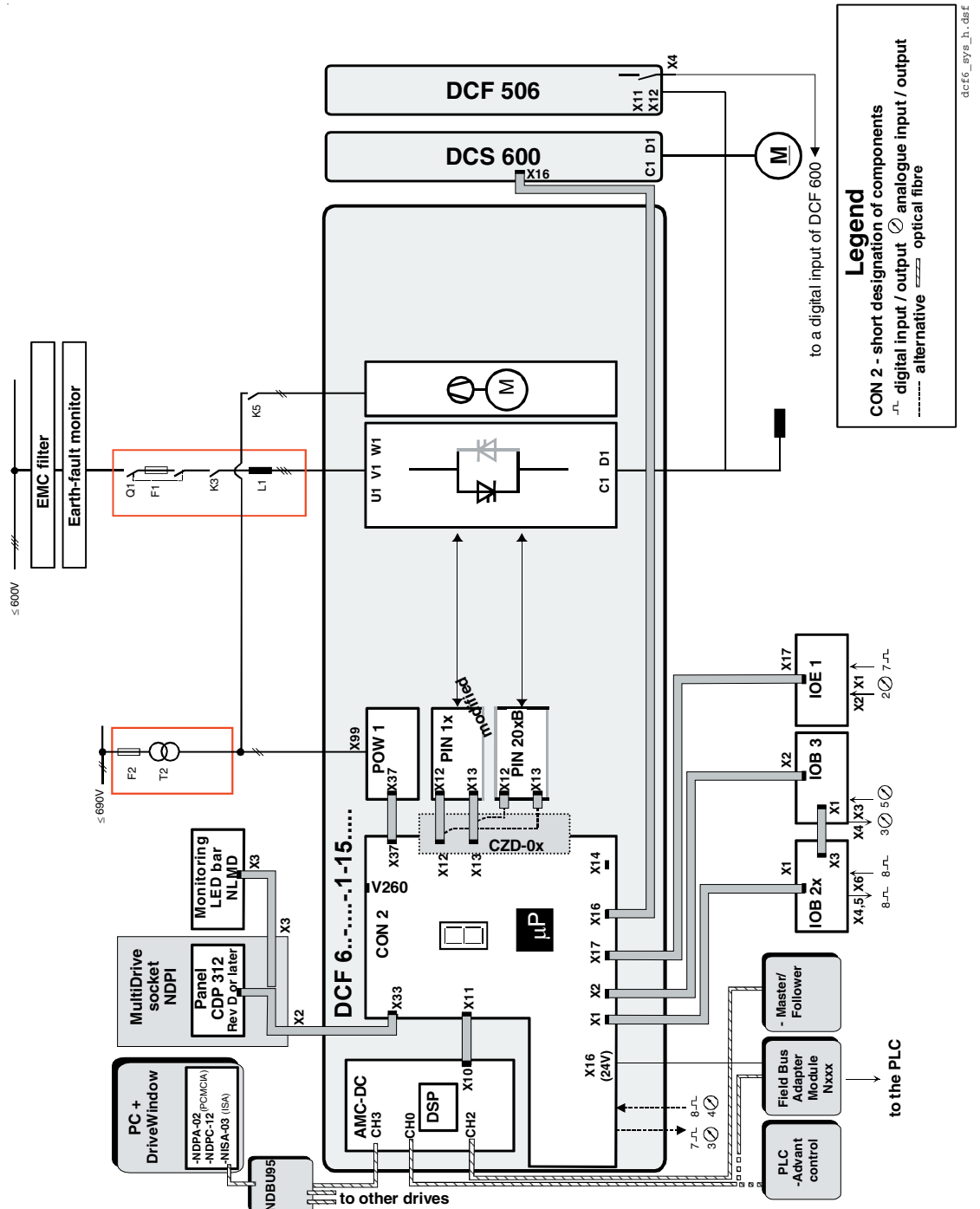

Fig. 2/2: DCS 600 MultiDrive Components overview for field supply converters

This overview has been designed to help you to familiarize yourself with the system; its main components are shown in the diagram above. The system's heart is the DCF 600 field supply converter module.

## 2.1 Environmental Conditions

### System connection

Voltage, 3-phase:	230 to 1000 V acc. to IEC 60038
Voltage deviation:	±10% continuous; ±15% short-time *
Rated frequency:	50 Hz or 60 Hz
Static frequency deviation:	50 Hz ±2 %; 60 Hz ±2 %
Dynamic: frequency range:	50 Hz: ±5 Hz; 60 Hz: ± 5 Hz
df/dt:	17 % / s

\* = 0.5 to 30 cycles.

**Please note:** Special consideration must be taken for voltage deviation in regenerative mode.

### Degree of protection

Converter Module and options

(line chokes, fuse holder,

field supply unit, etc.): IP 00

Enclosed converters: IP 20/21/31/41

### Paint finish

Converter module: NCS 170 4 Y015R

Enclosed converter: light grey RAL 7035

### Environmental limit values

Permissible cooling air temperature

- at converter module air inlet:	0 to +55°C
with rated DC current:	0 to +40°C
w. different DC curr. acc. Fig. 2.1/2:	+30 to +55°C

- Options:

Relative humidity (at 5...+40°C): 5 to 95%, no condensation

Relative humidity (at 0...+5°C): 5 to 50%, no condensation

Change of the ambient temp.: < 0.5°C / minute

Storage temperature: -40 to +55°C

Transport temperature: -40 to +70°C

Pollution degree (IEC 60664-1, IEC 60439-1): 2

Site elevation:

<1000 m above M.S.L.: 100%, without current reduction

>1000 m above M.S.L.: with current reduct., see Fig. 2.1/1

Size	Sound pressure level L <sub>p</sub> (1 m distance)		Vibration
	as module	enclosed conv.	
C1	59 dBA	57 dBA	as module 0.5 g, 5...55 Hz
C2	75 dBA	77 dBA	
A5	73 dBA	78 dBA	1 mm, 2...9 Hz 0.3 g, 9...200 Hz
A6	75 dBA	73 dBA	
A7	82 dBA	80 dBA	

### Current reduction to (%)

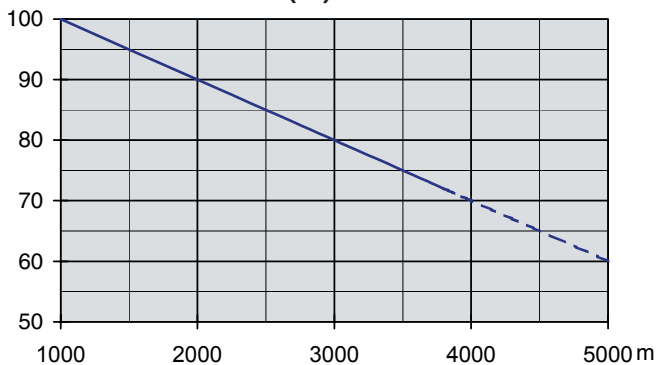

Fig. 2.1/1: Effect of the site elevation above sea level on the converter's load capacity.

### Regulatory Compliance

The converter module and enclosed converter components are designed for use in industrial environments. In EEA countries, the components fulfil the requirements of the EU directives, see table below.

European Union Directive	Manufacturer's Assurance	Harmonized Standards	
		Converter module	Enclosed converter
<b>Machinery Directive</b> 98/37/EEC 93/68/EEC	Declaration of Incorporation	EN 60204-1 [IEC 60204-1]	EN 60204-1 [IEC 60204-1]
<b>Low Voltage Directive</b> 73/23/EEC 93/68/EEC	Declaration of Conformity	EN 60146-1-1 [IEC 60146-1-1] ( EN 50178 [IEC --] see additional IEC 60664 )	EN 60204-1 [IEC 60204-1] ( EN 60439-1 [IEC 60439-1] )
<b>EMC Directive</b> 89/336/EEC 93/68/EEC	Declaration of Conformity (Provided that all installation instructions concerning cable selection, cabling and EMC filters or dedicated transformer are followed.)	EN 61800-3 ① [IEC 61800-3]	EN 61800-3 ① [IEC 61800-3]
		① in accordance with 3ADW 000 032	① in accordance with 3ADW 000 032/ 3ADW 000 091

### Current reduction to (%)

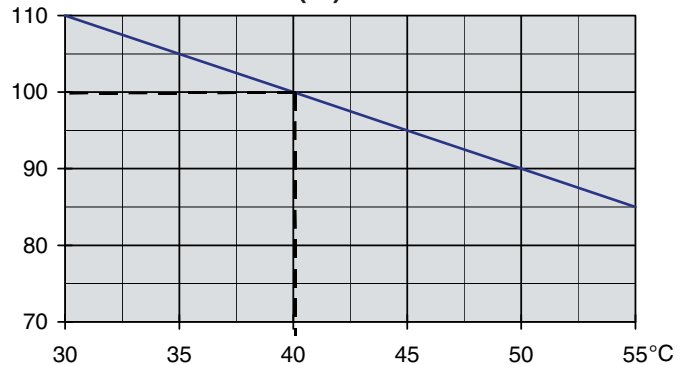

Fig. 2.1/2: Effect of the ambient temperature on the converter module load capacity.

### North American Standards

In North America the system components fulfil the requirements of the table below.

Rated supply voltage	Standards	
	Converter module	Enclosed converter
to 600 V	UL 508 C Power Conversion Equipment CSA C 22.2 No. 14-95 Industrial Control Equipment, Industrial Products Available for converter modules including field exciter units. Types with UL mark: • see UL Listing <a href="http://www.ul.com">www.ul.com</a> / certificate no. E196914 • or on request	UL/CSA types: on request
> 600 V to 1000 V	EN / IEC xxxxx see table on the left Available for converter modules including field exciter units.	EN / IEC types: on request (for details see table on the left)

## 2.2 DCS 600 Power Converter Modules

The power converter modules are modular in construction. They are based on the housing, which contains the power section with the RC snubber circuit. There are different sizes, depending on current and voltage. All units are forced cooled.

The power section is controlled by the unit's electronic system, which is identical for the entire product range. Parts of the unit's electronic system can be installed in the unit, depending on the particular application in-

volved, e.g. a field supply for the motor, or an interface board to connect the converter to an overriding control system. A control/display panel is available for the operator. It can be mounted to the power converter module or installed in the cabinet's door by means of a mounting kit.

Accessories such as external fuses, line reactors and the like are available, for putting together a complete drive system.

### Reference variables

The voltage characteristics are shown in Table 2.2/1. The DC voltage characteristics have been calculated using the following assumptions:

- $U_{VN}$  = rated mains voltage, 3-phase
- Voltage tolerance  $\pm 10\%$
- Internal voltage drop approx. 1%
- If a deviation or a voltage drop has to be taken into consideration in compliance with IEC and VDE standards, the output voltage or the output current must be reduced by the actual factor according to table 2.2/1.

System connection voltage $U_{VN}$	DC voltage (recommended)		Ideal DC voltage without load $U_{di0}$	Recommended DCS 500B Voltage class y=
	$U_{dmax\ 2-Q}$	$U_{dmax\ 4-Q}$		
230	265	240	310	4
380	440	395	510	4
400	465	415	540	4
415	480	430	560	4
440	510	455	590	5
460	530	480	620	5
480	555	500	640	5
500	580	520	670	5
525	610	545	700	6
575	670	600	770	6
600	700	625	810	6
660	765	685	890	7
690	800	720	930	7
790	915	820	1060	8
1000	1160	1040	1350	9
1190	1380	1235	1590	1

Table 2.2/1: DCS 600 max. DC voltages achievable with a specified input voltage.

**If armature voltages higher than recommended are requested, please check carefully, whether your system is still working under safe conditions.**

Application	Armature converter	Max. permitted armature voltage depending on Field exciter type		
		SDCS-FEX-1	SDCS-FEX-2A DCF 503A/504A DCF 501B	DCF 504A DCF 502B
Power always positive ( $U_a$ and $I_a$ pos.). <b>Extruder</b>	2-Q	$U_{dmax\ 2-Q}$	$U_{dmax\ 2-Q}$	-
Power often or always negative. <b>Unwinder, suspended load</b>	2-Q	$U_{dmax\ 4-Q}$	$U_{dmax\ 4-Q}$	$U_{dmax\ 4-Q}$
Power sporadically negative. <b>Printing machine at electrical stop</b>	2-Q	-	-	$U_{dmax\ 2-Q}$ + change software parameter
Power positive or negative. <b>Test rig</b>	4-Q	$U_{dmax\ 4-Q}$	$U_{dmax\ 4-Q}$	-
Power positive, sporadically negative.	4-Q	$U_{dmax\ 4-Q}$	$U_{dmax\ 2-Q}$ + change software parameter	-

Table 2.2/2: Maximum permitted armature voltage

Converter type → ↓ x=1 → 2-Q x=2 → 4-Q	y →				y=4 (400 V)		y=5 (500 V)		y=6 (600 V)		y=7 (690 V)	
	I <sub>DC</sub> [A]		I <sub>AC</sub> [A]		P [kW]		P [kW]		P [kW]		P [kW]	
	4Q	2Q	4Q	2Q	4Q	2Q	4Q	2Q	4Q	2Q	4Q	2Q
DCS60x-0025-y1	25	25	20	20	10	12	13	15				
DCS60x-0050-y1	50	50	41	41	21	23	26	29				
DCS60x-0050-61	50	50	41	41					31	35		
DCS60x-0075-y1	75	75	61	61	31	35	39	44				
DCS60x-0100-y1	100	100	82	82	42	47	52	58				
DCS60x-0110-61	110	100	90	82					69	70		
DCS60x-0140-y1	140	125	114	102	58	58	73	73				
DCS60x-0200-y1	200	180	163	147	83	84	104	104				
DCS60x-0250-y1	250	225	204	184	104	105	130	131				
DCS60x-0270-61	270	245	220	200					169	172		
DCS60x-0350-y1	350	315	286	257	145	146	182	183				
DCS60x-0450-y1	450	405	367	330	187	188	234	235	281	284		
DCS60x-0520-y1	520	470	424	384	216	219	270	273				
DCS60x-0680-y1	680	610	555	500	282	284	354	354				
DCS60x-0820-y1	820	740	670	605	340	344	426	429				
DCS60x-1000-y1	1000	900	820	738	415	418	520	522				
DCS60x-0903-y1	900	900	734	734					563	630	648	720
DCS60x-1203-y1	1200	1200	979	979	498	558	624	696				
DCS60x-1503-y1	1500	1500	1224	1224	623	698	780	870	938	1050	1080	1200
DCS60x-2003-y1	2000	2000	1632	1632	830	930	1040	1160		1400		1600
DCF60x-0025-y1	25	25	20	20	10	12	13	15				
DCF60x-0050-y1	50	50	41	41	21	23	26	29				
DCF60x-0075-y1	75	75	61	61	31	35	39	44				
DCF60x-0100-y1	100	100	82	82	42	47	52	58				
DCF60x-0200-y1	200	180	163	147	83	84	104	104				
DCF60x-0350-y1	350	315	286	257	145	146	182	183				
DCF60x-0450-y1	450	405	367	330	187	188	234	235				
DCF60x-0520-y1	520	470	424	384	216	219	270	273				

Table 2.2/3: Table of DCS 600 / DCF 600 units - construction types C1, C2, A5

Converter type →	y →		y=4 (400 V)	y=5 (500 V)	y=6 (600 V)	y=7 (690 V)	y=8 (790 V)	y=9 (1000V)	y=1 (1190V)
	I <sub>DC</sub> [A]	I <sub>AC</sub> [A]	P [kW]	P [kW]	P [kW]	P [kW]	P [kW]	P [kW]	P [kW] ①
<b>2-Q converters</b>									
DCS601-1903-y1	1900	1550					1740		
DCS601-2053-y1	2050	1673		1190	1430	1640			
DCS601-2503-y1	2500	2040	1160	1450	1750	2000	2300		
DCS601-3003-y1	3000	2448	1395	1740	2090	2400	2750		
DCS601-2053-y1	2050	1673						2390	
DCS601-2603-y1	2600	2121						3030	<i>on request</i>
DCS601-3303-y1	3300	2693	1540	1925	2310	2660	3040	3850	<i>on request</i>
DCS601-4003-y1	4000	3264	1870	2330	2800	3220	3690	4670	<i>on request</i>
DCS601-4803-y1	4800	3917			3360	3860	4420		
DCS601-5203-y1	5200	4243	2430	3030					
<b>4-Q converters</b>									
DCS602-1903-y1	1900	1550					1560		
DCS602-2053-y1	2050	1673		1070	1280	1470			
DCS602-2503-y1	2500	2040	1040	1300	1560	1800	2060		
DCS602-3003-y1	3000	2448	1250	1560	1880	2150	2470		
DCS602-2053-y1	2050	1673						2390	
DCS602-2603-y1	2600	2121						3030	<i>on request</i>
DCS602-3303-y1	3300	2693	1375	1720	2060	2370	2720	3440	<i>on request</i>
DCS602-4003-y1	4000	3264	1670	2080	2500	2875	3290	4170	<i>on request</i>
DCS602-4803-y1	4800	3917			3000	3450	3950		
DCS602-5203-y1	5200	4243	2170	2710					

① These converters are equipped with additional components. More information on request

Table 2.2/4: Table of DCS 600 units - construction type A6 / A7

**Higher currents up to 15,000 A are achieved by paralleling converters - information on request.**



Construction type C1 Construction type C2

Construction type A5

Construction type A6

Construction type A7  
left busbar connection

Converter type ②	Dimensions H x W x D [mm]	Weight [kg]	Clearances top/bottom/side [mm]	Construct. type	Power loss at 500V P <sub>v</sub> [kW]	Fan connection	Semiconductor Fuses
DCS60x-0025-y1	420x273x195	7.1	150x100x5	C1a	< 0.2	230 V/1 ph	external
DCS60x-0050-y1	420x273x195	7.2	150x100x5	C1a	< 0.2	230 V/1 ph	external
DCS60x-0050-61	420x273x195	7.6	150x100x5	C1a	-	230 V/1 ph	external
DCS60x-0075-y1	420x273x195	7.6	150x100x5	C1a	< 0.3	230 V/1 ph	external
DCS60x-0100-y1	469x273x228	11.5	250x150x5	C1b	< 0.5	230 V/1 ph	external
DCS60x-0110-61	469x273x228	11.5	250x150x5	C1b	-	230 V/1 ph	external
DCS60x-0140-y1	469x273x228	11.5	250x150x5	C1b	< 0.6	230 V/1 ph	external
DCS60x-0200-y1	505x273x361	22.3	250x150x5	C2a	< 0.8	230 V/1 ph	external
DCS60x-0250-y1	505x273x361	22.3	250x150x5	C2a	< 1.0	230 V/1 ph	external
DCS60x-0270-61	505x273x361	22.8	250x150x5	C2a	-	230 V/1 ph	external
DCS60x-0350-y1	505x273x361	22.8	250x150x5	C2a	< 1.3	230 V/1 ph	external
DCS60x-0450-y1	505x273x361	28.9	250x150x10	C2a	< 1.5	230 V/1 ph	external
DCS60x-0520-y1	505x273x361	28.9	250x150x10	C2a	< 1.8	230 V/1 ph	external
DCS60x-0680-y1	652x273x384	42	250x150x10	C2b	< 1.6	230 V/1 ph	external
DCS60x-0820-y1	652x273x384	42	250x150x10	C2b	< 2.0	230 V/1 ph	external
DCS60x-1000-y1	652x273x384	42	250x150x10	C2b	< 2.5	230 V/1 ph	external
DCS60x-0903-y1	1050x510x410	110	300x100x20	A5	-	230 V/1-ph	internal
DCS60x-1203-y1	1050x510x410	110	300x100x20	A5	< 5.2	230 V/1-ph	internal
DCS60x-1503-y1	1050x510x410	110	300x100x20	A5	< 5.5	230 V/1-ph	internal
DCS60x-2003-y1	1050x510x410	110	300x100x20	A5	< 6.6	230 V/1-ph	internal
DCS60x-1903-81	1750x460x410	180	③ x0x50	A6	-	400...500 V/3-ph	internal
DCS60x-2053-y1	1750x460x410	180	③ x0x50	A6	< 7.9	at y = 4, 5, 8	
DCS60x-2503-y1	1750x460x410	180	③ x0x50	A6	< 9.3	500...690 V/3-ph	
DCS60x-3003-y1	1750x460x410	180	③ x0x50	A6	< 11.9	at y = 6, 7	
DCS60x-2053-y1L①	1750x770x570	315	} to be installed in cubicle	A7	-	400/690 V/3-ph	internal
DCS60x-2603-y1L①	1750x770x570	315		A7	-	400/690 V/3-ph	
DCS60x-3203-y1L①	1750x770x570	315		A7	-	400/690 V/3-ph	
DCS60x-3303-y1L①	1750x770x570	315		A7	< 15	400/690 V/3-ph	
DCS60x-4003-y1L①	1750x770x570	315		A7	< 16	400/690 V/3-ph	
DCS60x-4803-y1L①	1750x770x570	315		A7	-	400/690 V/3-ph	
DCS60x-5203-y1L①	1750x770x570	315		A7	< 20	400/690 V/3-ph	

① Busbar connection on the right side is optional

Example for the type designation: connection left DCS60x-5203-y1L; connection right DCS60x-5203-y1R)

② x=1 → 2-Q; x=2 → 4-Q; y=4...9/1 → 400...1000 V/1190 V supply voltage

③ Exhaust air must leave enclosure via air channel

also available as field supply converter DCF60x (for 500 V s. also table 2.2/3). Data are the same as the armature current converter DCS60x

Table 2.2/5: Table of DCS 600 units

## 2.3 DCS 600 Overload Capability

To match a drive system's components as efficiently as possible to the driven machine's load profile, the armature power converters DCS 600 can be dimensioned by means of the load cycle. Load cycles for driven machines have been defined in the IEC 146 or IEEE specifications, for example.

The currents for the DC I to DC IV types of load (see diagram on the following page) for the power converter modules are listed in the table below.

Unit type	$I_{DC I}$ continuous [A]	$I_{DC II}$		$I_{DC III}$		$I_{DC IV}$	
		100 % 15 min	150 % 60 s	100 % 15 min	150 % 120 s	100 % 15 min	200 % 10 s
<b>400 V / 500 V</b>							
DCS 60x-0025-41/51	25	24	36	23	35	24	48
DCS 60x-0050-41/51	50	44	66	42	63	40	80
DCS 60x-0075-41/51	75	60	90	56	84	56	112
DCS 60x-0100-41/51	100	71	107	69	104	68	136
DCS 601-0140-41/51	125	94	141	91	137	90	180
DCS 602-0140-41/51	140	106	159	101	152	101	202
DCS 601-0200-41/51	180	133	200	132	198	110	220
DCS 602-0200-41/51	200	149	224	146	219	124	248
DCS 601-0250-41/51	225	158	237	155	233	130	260
DCS 602-0250-41/51	250	177	266	173	260	147	294
DCS 601-0350-41/51	315	240	360	233	350	210	420
DCS 602-0350-41/51	350	267	401	258	387	233	466
DCS 601-0450-41/51	405	317	476	306	459	283	566
DCS 602-0450-41/51	450	352	528	340	510	315	630
DCS 601-0520-41/51	470	359	539	347	521	321	642
DCS 602-0520-41/51	520	398	597	385	578	356	712
DCS 601-0680-41/51	610	490	735	482	732	454	908
DCS 602-0680-41/51	680	544	816	538	807	492	984
DCS 601-0820-41/51	740	596	894	578	867	538	1076
DCS 602-0820-41/51	820	664	996	648	972	598	1196
DCS 601-1000-41/51	900	700	1050	670	1005	620	1240
DCS 602-1000-41/51	1000	766	1149	736	1104	675	1350
DCS 60x-1203-41/51	1200	888	1332	872	1308	764	1528
DCS 60x-1503-41/51	1500	1200	1800	1156	1734	1104	2208
DCS 60x-2003-41/51	2000	1479	2219	1421	2132	1361	2722
DCS 60x-2053-51	2050	1550	2325	1480	2220	1450	2900
DCS 601-2503-41/51	2500	1980	2970	1880	2820	1920	3840
DCS 602-2503-41/51	2500	2000	3000	1930	2895	1790	3580
DCS 601-3003-41/51	3000	2350	3525	2220	3330	2280	4560
DCS 602-3003-41/51	3000	2330	3495	2250	3375	2080	4160
DCS 60x-3303-41/51	3300	2416	3624	2300	3450	2277	4554
DCS 60x-4003-41/51	4000	2977	4466	2855	4283	2795	5590
DCS 60x-5203-41/51	5200	3800	5700	3669	5504	3733	7466
<b>600 V / 690 V</b>							
DCS 60x-0050-61	50	44	66	43	65	40	80
DCS 601-0110-61	100	79	119	76	114	75	150
DCS 602-0110-61	110	87	130	83	125	82	165
DCS 601-0270-61	245	193	290	187	281	169	338
DCS 602-0270-61	270	213	320	207	311	187	374
DCS 601-0450-61	405	316	474	306	459	282	564
DCS 602-0450-61	450	352	528	340	510	313	626
DCS 60x-0903-61/71	900	684	1026	670	1005	594	1188
DCS 60x-1503-61/71	1500	1200	1800	1104	1656	1104	2208
DCS 601-2003-61/71	2000	1479	2219	1421	2132	1361	2722
DCS 60x-2053-61/71	2050	1520	2280	1450	2175	1430	2860
DCS 601-2503-61/71	2500	1940	2910	1840	2760	1880	3760
DCS 602-2503-61/71	2500	1940	2910	1870	2805	1740	3480
DCS 601-3003-61/71	3000	2530	3795	2410	3615	2430	4860
DCS 602-3003-61/71	3000	2270	3405	2190	3285	2030	4060
DCS 60x-3303-61/71	3300	2416	3624	2300	3450	2277	4554
DCS 60x-4003-61/71	4000	3036	4554	2900	4350	2950	5900
DCV 60x-4803-61/71	4800	3734	5601	3608	5412	3700	7400
<b>790 V</b>							
DCS 60x-1903-81	1900	1500	2250	1430	2145	1400	2800
DCS 601-2503-81	2500	1920	2880	1820	2730	1860	3720
DCS 602-2503-81	2500	1910	2865	1850	2775	1710	3420
DCS 601-3003-81	3000	2500	3750	2400	3600	2400	4800
DCS 602-3003-81	3000	2250	3375	2160	3240	2000	4000
DCS 60x-3303-81	3300	2655	3983	2540	3810	2485	4970
DCS 60x-4003-81	4000	3036	4554	2889	4334	2933	5866
DCS 60x-4803-81	4800	3734	5601	3608	5412	3673	7346
<b>1000 V</b>							
DCS 60x-2053-91	2050	1577	2366	1500	2250	1471	2942
DCS 60x-2603-91	2600	2000	3000	1900	2850	1922	3844
DCS 60x-3303-91	3300	2551	3827	2428	3642	2458	4916
DCS 60x-4003-91	4000	2975	4463	2878	4317	2918	5836
<b>1190 V</b>							
Data on request							

x=1 → 2-Q; x=2 → 4-Q

Table 2.3/1:  
Power converter module currents with corresponding load cycles.  
The characteristics are based on an ambient temperature of max. 40°C and an elevation of max. 1000 m a.s.l.

## Types of load

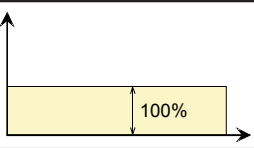
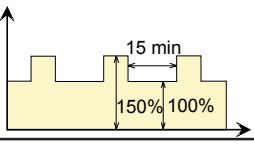
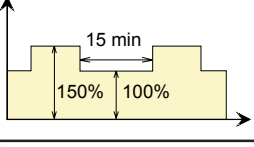
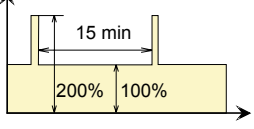
Load cycle	Load for converter	Typical applications	Load cycle
DC I	$I_{DC I}$ continuous ( $I_{dN}$ )	pumps, fans	
DC II	$I_{DC II}$ for 15 min and $1,5 * I_{DC II}$ for 60 s	extruders, conveyor belts	
DC III *	$I_{DC III}$ for 15 min and $1,5 * I_{DC III}$ for 120 s	extruders, conveyor belts	
DC IV *	$I_{DC IV}$ for 15 min and $2 * I_{DC IV}$ for 10 s		

\* Load cycle is **not** identical with menu item *Duty cycle* in DCSize !  
Table 2.3/2: Definition of the load cycles

If the driven machine's load cycle does not correspond to one of the examples listed, you can determine the necessary power converter using the DCSize software program.

This program can be run under Microsoft® Windows, and enables you to dimension the motor and the power converter, taking types of load (load cycle), ambient temperature, site elevation, etc. into account. The design result will be presented in tables, charts, and can be printed out as well.

To facilitate the start-up procedure as much as possible the converter's software is structured similar as the inputs made at the program. Because of that many of the data can be directly utilized at the converter like high current, line voltage and others.

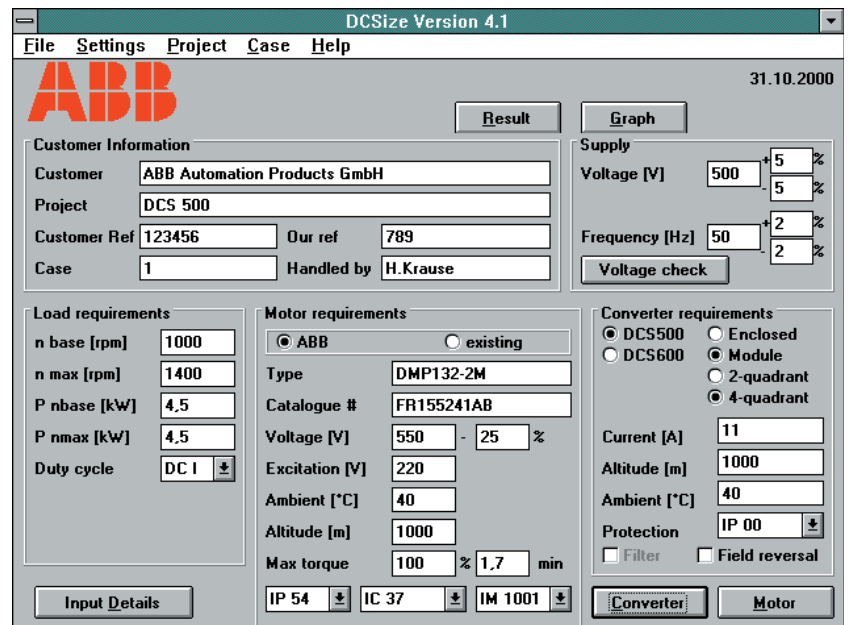

Fig. 2.3/1: Entry screen of DCSize.

Microsoft is a registered trademark. Windows is a designation of the Microsoft Corporation.

## 2.4 Field Supply

### General data

- Currents from 6 to 520 A.
- Minimum field current monitor.
- Integrated or external field power converter or in a completely separate cabinet.
- 2-phase or 3-phase model.
- Fully digital control (except SDCS-FEX-1).

We recommend integrating an autotransformer in the field power converter's supply to adjust the AC input voltage to the field voltage, to reduce the voltage and current ripple of the field.

All field power converters (except for the SDCS-FEX-1) are controlled by the armature converter via a serial link with a speed of 62.5 kBaud. The link serves to parameterize, control and diagnose the field power converter and thus provides an exact control. Moreover, it enables you to control an internal (SDCS-FEX-2A) and an external (DCF 601/602/503A/504A) or two external field supply units (2 x DCF 601/602/503A/504A). The respective software function required is available in every DC power converter.

### Field converter types

#### SDCS-FEX-1

- Diode bridge.
- 6 A rated current.
- Internal non adjustable minimum field current monitor.
- Construction and components have been designed for an insulation voltage of 600 V AC.
- Output voltage  $U_A$ :

$$U_A = U_V * \left( \frac{100\% + TOL}{100\%} \right) * 0.9$$

TOL = tolerance of line voltage in %  
 $U_V$  = Line voltage

- Recommendation:  
Field voltage  $\sim 0.9 * U_V$



SDCS-FEX-1

#### SDCS-FEX-2A

- Half controlled thyristor/diode bridge (1-Q)
- Microprocessor control, with the electronic system being supplied by the armature converter.
- Construction and components have been designed for an insulation voltage of 600 V AC.
- Fast-response excitation is possible with an appropriate voltage reserve; de-excitation takes place by field time constant.
- Output voltage  $U_A$ :

$$U_A = U_V * \left( \frac{100\% + TOL}{100\%} \right) * 0.9$$

TOL = tolerance of line voltage in %  
 $U_V$  = Line voltage

- Recommendation:  
Field voltage 0.6 to 0.8 \*  $U_V$

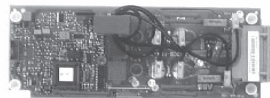

SDCS-FEX-2A

### DCF 503A

- Half controlled thyristor/diode bridge (1-Q).
- Microprocessor control with the control electronics being supplied separately (115...230 V/1-ph).
- Construction and components have been designed for an insulation voltage of 690 V AC.
- Output voltage  $U_A$ :

$$U_A = U_V * \left( \frac{100\% + TOL}{100\%} \right) * 0.9$$

TOL = tolerance of line voltage in %  
 $U_V$  = Line voltage

- Recommendation:  
 Field voltage 0.6 to 0.8 \*  $U_V$

### DCF 504A

- Fully controlled antiparallel thyristor bridges (4-Q).
- With this unit fast response excitation / de-excitation and field reversal is possible. For fast response excitation an appropriate voltage reserve is necessary.

In steady-state condition, the fully controlled bridge runs in half controlled mode to keep the voltage ripple as low as possible. With a fast changing field current, the bridge runs in fully controlled mode.

- Same design as DCF 503A

### DCF 600

This field power converter is used mainly for armature converters with rated currents of 2050 to 5200 A. It is a modified armature circuit converter.

- Output voltage  $U_A$  respectively  $U_{dmax\ 2-Q}$ :  
 see table 2.2/1.
- Recommendation:  
 Field voltage 0.5 to 1.1 \*  $U_V$
- The three-phase field supply converters DCF 600 needs a separate active overvoltage protection unit DCF 506 for protecting the power part against too high voltages.  
 The overvoltage protection unit DCF 506 is suitable for 2-Q converters DCF 601 and for 4-Q converters DCF 602.

### Assignment Field supply converter to Overvoltage protection unit

Field supply converter for motor fields	Overvoltage Protection
DCF60x-0025-51 ... DCF60x-0140-51	DCF506-0140-51
DCF60x-0200-51 ... DCF60x-0520-51	DCF506-0520-51



DCF503A/504A



DCF601/602



DCF506-140-51,  
without cover

Unit type	Output current $I_{DC}$ ① [A]	Supply voltage [V]	Installation site	Remarks
SDCS-FEX-1-0006 SDCS-FEX-2A-0016	0.02...6 0.3...16	110V -15%...500V/1-ph +10% 110V -15%...500V/1-ph +10%	internal internal	external fuse, 6 A $\Rightarrow I_{Rated}$ ext. fuse, reactor; for C1: 0.3 ... 8 A ①, not to be used for A6/A7 mod.!
DCF 503A-0050 DCF 504A-0050	0.3...50 0.3...50	110V -15%...500V/1-ph +10% 110V -15%...500V/1-ph +10%	external external	auxiliary supply (115...230V) if necessary via matching transformer; external fuse; Dimensions HxWxD: 370x125x342 [mm]
DCF 60x-xxxx-41/51	see table 2.2/2	200V...500V/3-ph	external	are based on the hardware of the DCS 600 and additional hardware components (DCF 506); auxiliary supply (115/230 V)

① Current reduction see also 2.1 Environmental conditions Fig.: 2.1/1 and 2.1/2  
 Table 2.4/1: Data field converter units

## 2.5 Options for DCS 600 MultiDrive converter modules

### In-/output signals

The converter can be connected in 4 different ways to a control unit via analogue/digital links. Only one of the four choices can be used at the same time. In

addition to this an extension of I/O's by SDCS-IOE 1 is possible.

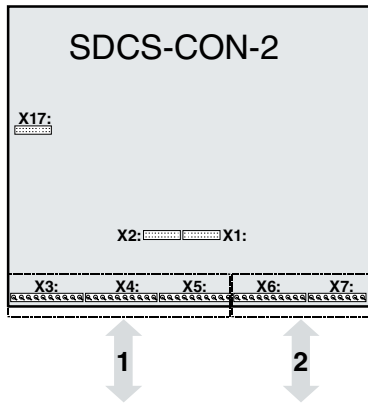

Fig. 2.5/1: I/O's via SDCS-CON-2

**Analogue I/O's:** standard  
**Digital I/O's:** not isolated  
**Encoder input:** not isolated

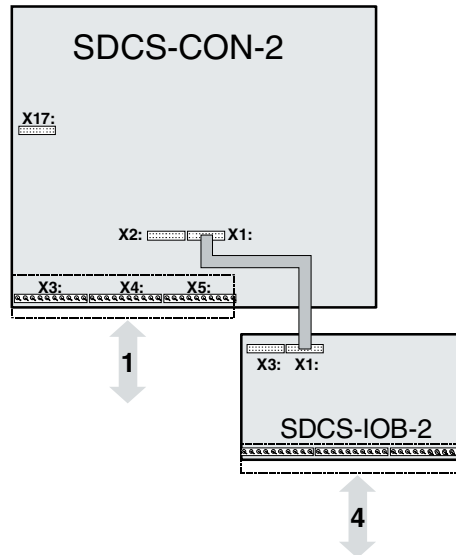

Fig. 2.5/2: I/O's via SDCS-CON-2 and SDCS-IOB-2

**Analogue I/O's:** standard  
**digital I/O's:** all isolated by means of optocoupler/relay; the signal status is indicated by LED

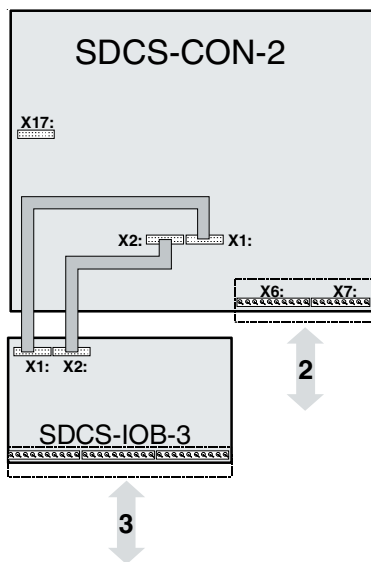

Fig. 2.5/3: I/O's via SDCS-CON-2 and SDCS-IOB-3

**Analogue I/O's:** more input capacity  
**digital I/O's:** not isolated  
**encoder input:** isolated  
**current source for:** PT100/PTC element

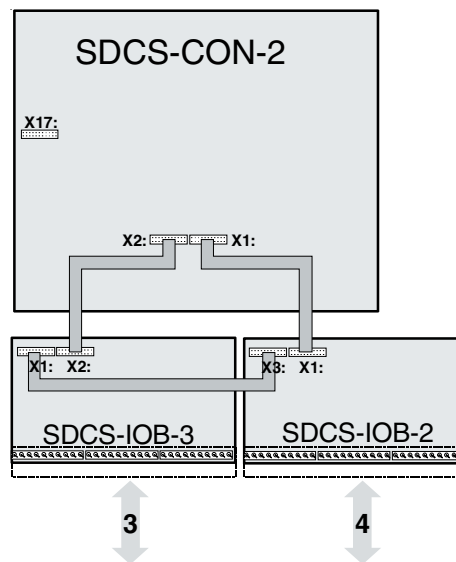

Fig. 2.5/4: I/O's via SDCS-IOB-2 and SDCS-IOB-3

**Analogue I/O's:** more input capacity  
**digital I/O's:** all isolated by means of optocoupler/relay; the signal status is indicated by LED  
**current source for:** PT100/PTC element

## Description of I/O signals SDCS-CON-2

**Mechanical system** integrated in control board

### Terminals

Screw type terminals for finely stranded wires up to 2.5 mm<sup>2</sup>

### Functionality

#### ⇒ 1 tachometer input

Resolution: 12 bit + sign; differential input; common mode range  $\pm 20$  V  
3 ranges from 8...30...90...270 VDC with  $n_{\max}$

#### ⇒ 4 analogue inputs

Range -10...0...+10 V, 4...20 mA, 0...20 mA  
All as differential inputs;  $R_E = 200$  k $\Omega$ ; time constant of smoothing capacitor  $\leq 2$  ms

**Input 1:** Resolution: 12 bit + sign; common mode range  $\pm 20$  V

**Inputs 2, 3, 4:** Resolution: 11 bit + sign; common mode range  $\pm 40$  V

**Current source** for PTC element evaluation via jumper and input 2

#### ⇒ 2 outputs

+10 V, -10 V,  $I_A \leq 5$  mA; sustained short-circuit-proof  
voltage supply for reference potentiometer

#### ⇒ 1 analogue output

bipolar current actual - from power section; decoupled  
 $I_{dN} = \pm 3$  V;  $I_A \leq 5$  mA, short-circuit-proof

#### ⇒ 2 analogue outputs

Range -10...0...+10 V;  $I_A \leq 5$  mA  
Output signal and scaling can be selected by means of software  
Resolution: 11 bit + sign

#### ⇒ 1 pulse generator input

Voltage supply for 5 V/12 V/24 V pulse generators (sustained short-circuit-proof)

Output current with  
5 V:  $I_A \leq 0.25$  A  
12 V:  $I_A \leq 0.2$  A  
24 V:  $I_A \leq 0.2$  A

Input range: 12 V/24 V: asymmetrical and differential  
5 V: differential

Pulse generator as 13 mA current source: differential  
Line termination (impedance 120 $\Omega$ ), if selected  
max. input frequency  $\leq 300$  kHz

#### ⇒ 8 digital inputs

The functions can be selected by means of software.  
Input voltage: 0...8 V  $\Rightarrow$  "0 signal", 16...60 V  $\Rightarrow$  "1 signal"

Time constant of smoothing capacitor: 10 ms

$R_E = 15$  k $\Omega$

The signal refers to the unit housing potential.

Auxiliary voltage for digital inputs: +48 V DC,  $\leq 50$  mA, sustained short-circuit-proof

#### ⇒ 7+1 digital outputs

The function can be selected by means of software.

7 outputs: relay driver with free-wheeling diode, total current limitation  $\leq 160$  mA; short-circuit-proof.

1 relay output - on power board SDCS-POW-1 (N.O. contact:

**AC:**  $\leq 250$  V /  $\leq 3$  A / **DC:**  $\leq 24$  V /  $\leq 3$  A or  $\leq 115/230$  V /  $\leq 0.3$  A) protected by VDR component.

## Description of I/O signals SDCS-IOB-2x & SDCS-IOB-3

**Mechanical system** always external, outside the module

### Terminals

Screw type terminals for finely stranded wires up to 2.5 mm<sup>2</sup>

### Functionality of SDCS-IOB-3

#### ⇒ 1 tachometer input

Resolution: 12 bit + sign; differential input; common mode range  $\pm 20$  V  
Range 8 V - with  $n_{\max}$ ; if higher tachometer voltages are in use tachometer adaptation board PS 5311 is needed.

#### ⇒ 4 analogue inputs

All as differential inputs; time constant of smoothing capacitor  $\leq 2$  ms  
**Input 1:** Range -10 V...0...+10 V; -20 mA...0...+20 mA; 4... 20 mA unipolar;  $R_E = 200$  k $\Omega$  / 500 $\Omega$  / 500 $\Omega$ ; Resolution: 12 bit + sign; common mode range  $\pm 20$  V

**Inputs 2+3:** Range see input 1, in addition -1 V...0...+1 V

$R_E = 200$  k $\Omega$  / 500 $\Omega$  / 500 $\Omega$  / 20k $\Omega$ ; Resolution: 11 bit + sign; common mode range with -1 V...0...+1 V range  $\pm 10$  V, otherwise  $\pm 40$  V

**Input 4:** Range see input 1

$R_E = 200$  k $\Omega$  / 500 $\Omega$  / 500 $\Omega$ ; Resolution: 11 bit + sign; common mode range  $\pm 40$  V

#### ⇒ Residual current detection in combination with analogue input 4 (sum of phase currents $\neq 0$ )

#### ⇒ 2 outputs

+10 V, -10 V;  $I_A \leq 5$  mA; sustained short-circuit-proof  
voltage supply for reference potentiometer

#### ⇒ 1 analogue output

Bipolar current actual - from power section; decoupled  
 $I_{dN} = \pm 3$  V (at gain = 1);  $I_A \leq 5$  mA;  $U_{Amax} = 10$  V; gain can be adjusted by means of a potentiometer between 0.5 and 5; short-circuit-proof

#### ⇒ 2 analogue outputs

Range -10...0...+10 V;  $I_A \leq 5$  mA; short-circuit-proof  
Output signal and scaling can be selected by means of software  
Resolution: 11 bit + sign

#### ⇒ Current source for PT 100 or PTC element

$I_A = 5$  mA / 1.5 mA

#### ⇒ 1 pulse generator input

Voltage supply, output current, input range: **see SDCS-CON-2**  
Inputs electrically isolated from 0 V (housing) by means of optocoupler and voltage source.

### Functionality of SDCS-IOB-2x

#### 3 different designs available:

○ **SDCS-IOB-21** inputs for 24...48 V DC;  $R_E = 4.7$  k $\Omega$

○ **SDCS-IOB-22** inputs for 115 V AC;  $R_E = 22$  k $\Omega$

○ **SDCS-IOB-23** inputs for 230 V AC;  $R_E = 47$  k $\Omega$

### Terminals

Screw type terminals up to 4 mm<sup>2</sup>

#### ⇒ 8 digital inputs

The functions can be selected by means of software.

The signal status is indicated by LED.

All isolated by means of optocouplers.

Input voltage: IOB-21: 0...8 V  $\Rightarrow$  "0 signal", 18...60 V  $\Rightarrow$  "1 sig."  
IOB-22: 0...20 V  $\Rightarrow$  "0 signal", 60...130 V  $\Rightarrow$  "1 sig."  
IOB-23: 0...40 V  $\Rightarrow$  "0 signal", 90...250 V  $\Rightarrow$  "1 sig."

Filter time constant: 10 ms (channels 1...6); 2 ms (channels 7+8)

Auxiliary voltage for digital inputs: +48 V DC;  $\leq 50$  mA; sustained short-circuit-proof; referenced to the unit housing potential.

#### ⇒ 8 digital outputs

The functions can be selected by means of software.

The signal status is indicated by LED.

6 of them potential isolated by relay (N.O. contact: **AC:**  $\leq 250$  V /  $\leq 3$  A /

**DC:**  $\leq 24$  V /  $\leq 3$  A or  $\leq 115/230$  V /  $\leq 0.3$  A), protected by VDR component.

2 of them potential isolated by optocoupler, protected by zener diode (open collector) 24 V DC external,  $I_A \leq 50$  mA.

## Serial interfaces

There are various serial interface options available for operation, commissioning, diagnosis and controlling. For the control and display panel CDP 312 are serial connections X33:/X34: on the SDCS-CON-2 available. Three additional serial interfaces are available on the SDCS-AMC-DC 2 board.

These interfaces use plastic or HCS optical fibres. Channel 3 is used for drive/PC interfacing. Channel 0 for fieldbus module interfacing or communication to the overriding control system. Channel 2 is used for Master-Follower link or for I/O extension. All three serial interfaces are independent from each other.

Different SDCS-AMC 2 boards are available to adapt optical cables, cable length and serial interfaces. The different SDCS-AMC 2 boards are equipped with 10 or 5 Mbaud optical transmitter and receiver devices.

A few basic rules must be considered:

- Never connect 5 Mbaud and 10 Mbaud devices.
- 5 Mbaud can handle only plastic fibre optic.
- 10 Mbaud can handle plastic or HCS cable.
- The branching unit NDBU 95 extends the maximum distance.
- The maximum distance and suitable configuration can be found in the manual *Configuration Instructions NDBU 85/95*; Doc no.: 3ADW000100.

### Remark:

Fieldbus modules Nxxx (CH0) require the SDCS-AMC-DC **Classic 2** board - all others (FCI, AC80...) require the SDCS-AMC-DC 2 board.

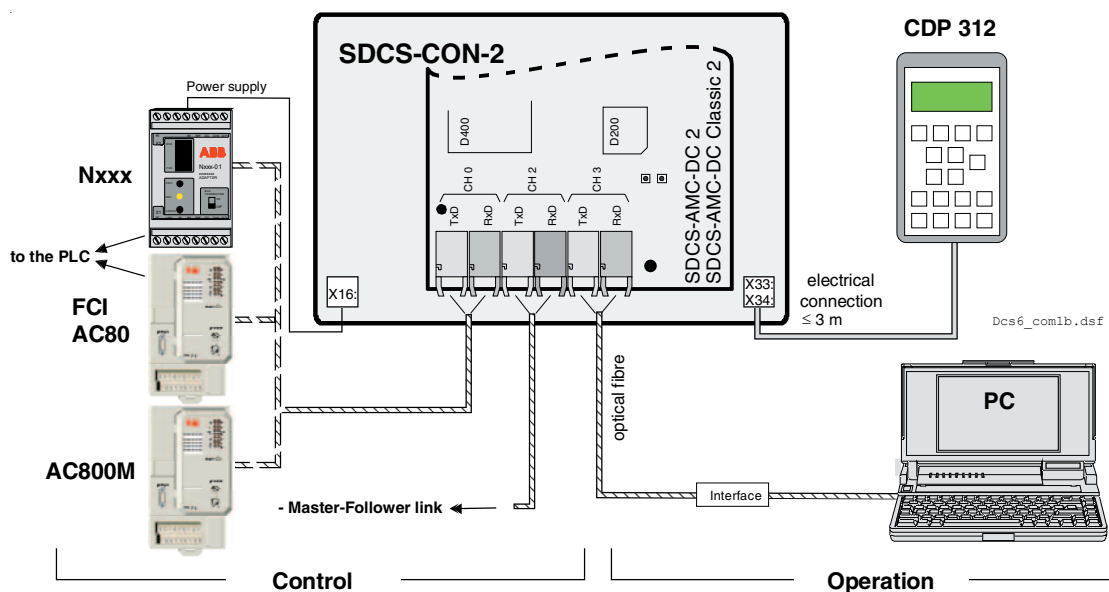

Fig. 2.5/5: Options for serial communication

## Operation by panel

### Panel location

There are different possibilities for mounting the panel:

- On the converter module.
- With MultiDrive door mounting kit.

### LED Monitoring Display

If the MultiDrive door Mounting kit is used it is possible to insert up to three LED monitoring displays for indicating status as run, ready and fault and a selectable parameter indicator (0...150%) per drive. The display is connected to the SDCS-CON-2 board (X33:/X34:) or to the panel socket NDPI through a universal Modbus link.

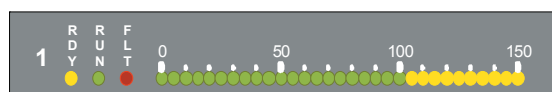

Fig. 2.5/6: LED Monitoring Display

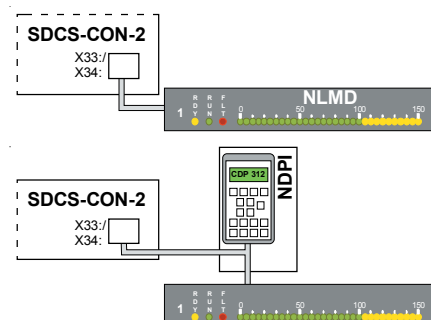

Fig. 2.5/7: Connection of the LED Monitoring Display

## Panel (control and display panel)

The CDP 312 control and display panel communicates with the power converter via a serial connection in accordance with the RS 485 standard at a transmission rate of 9.6 kBaud. It is an option for the converter unit. After completion of commissioning, the panel is not necessarily required for diagnostic. The basic unit has a 7-segment display indicating errors.

## Features

- 16 membrane pushbuttons in three function groups
- LCD display has four lines with 20 characters each
- Language: English
- Options for the CDP 312:
  - cable, separated from the power converter for utilization; 3 m long
  - kit for mounting the panel in the switchgear cubicle door

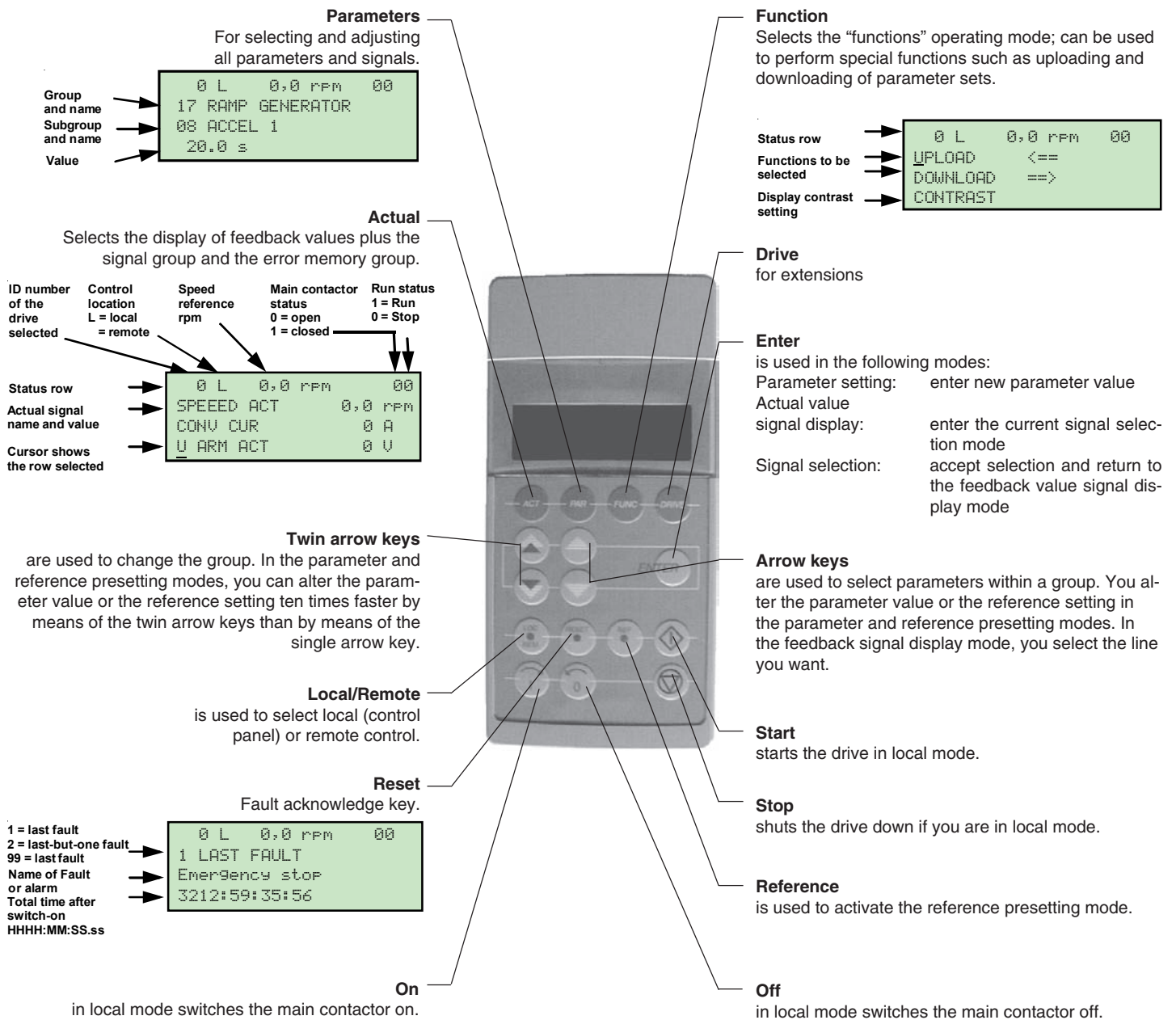

Fig. 2.5/8: Function keys and various displays on the removable control and display panel.

## Operation by PC

### Components required:

- Plastic optical fibre for distances up to 20 m.
- Network up to 200 drives (same as for ACS 600).
- HCS optical fibre cable up to 200 m.  
See separate manual *Configuration Instructions NDBU 85/95*; Doc no.: 3ADW000100.

### Functionality:

- DriveWindow software package<sup>①</sup> for commissioning, diagnosis, maintenance and trouble shooting; structure of connections see *Technical Data*; Doc no.: 3ADW000165.

### System requirements/recommendation:

- PC (IBM-compatible) with 486 processor or higher (min. 50 MHz).
- 8 MB RAM.
- DOS version 5.0 or later.
- Windows NT4.0, WIN 2000, WIN XP
- VGA monitor.
- CD-ROM drive.
- PCMCIA slot or PCI/PCMCIA bridge.

In addition to the options provided by the CDP 312 control and display panel, there are further functions available, and these are described on the following page.

## Drive control

### Components required:

- Plastic optical fibre for distances up to 15 m.
- Field bus module Nxxx-xx
- FCI (CI810)
- AC80 (PM825)
- AC800 M

### Functionality:

Depends on the used module, interface e.g. to:

- PROFIBUS with NPBA-12
- MODBUS with NMBA-01
- AF100 with FCI (CI810)
- AC80 (PM825) or
- AC800 M
- further modules on request

You will find more detailed information on data exchange in the specific PLC or fieldbus module documentation.

<sup>①</sup> For further information see the specific publications

## Operation by PC (continued)

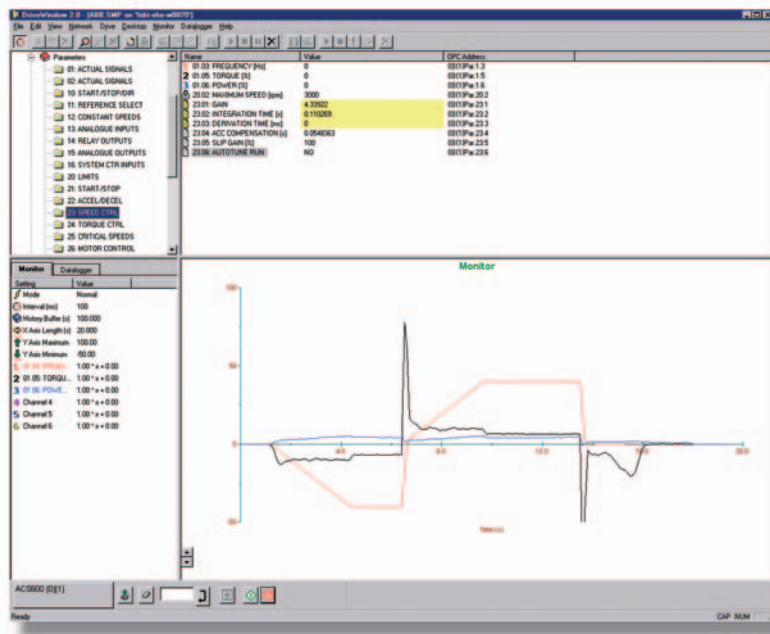

### Features

- Easy-to-use tool for commissioning and maintenance.
- Several drives connected and monitored at the same time.
- Monitor, edit or save signals and parameters, clear graphical presentation.
- High speed communication between PC and drive
- Versatile back-up functions.

### DriveWindow 2.xx Windows™ -based, user-friendly

ABB's DriveWindow is an advanced, easy-to-use tool for the commissioning and maintenance of drive systems in different industries. Its host of features and clear, graphical presentation of the operation make it a valuable addition to your system providing information necessary for troubleshooting, maintenance and service, as well as training.

DriveWindow is fully 32 bit and runs in the newer Microsoft® Windows environments such as WIN NT / 2000 / XP.

With DriveWindow the user is able to follow the cooperation of two or more drives simultaneously by collecting the actual values from the drives onto a single screen or printout.

Additionally, the client part of DriveWindow may reside on one Local Area Network PC, and the server side on another PC closer to the drives. This enables plant-wide monitoring to be easily accomplished with two PCs.

### Powerful and versatile

- DriveWindow can access all drives connected to the high speed fiber optic network see manuals:
  - *Configuration Instructions NDBU-85/95* (3ADW000100).
  - *NDBU-85/95 Branching Units* (3BFE6428513).
  - *DDCS Cabling and Branching* (3AFE63988235).
- Signal values can be viewed as graphs from the drive/drives.
- A screenful of signals and parameters from the drive can be monitored and edited at one time (off-line or on-line).
- View data collected and stored in the drive.
- Fault diagnosis; DriveWindow indicates the status of drives, and also reads fault history data from the drive.
- Remote monitoring, plant wide monitoring with two PCs.
- Back-up of drive parameters; in fault situations the file can be easily reloaded, resulting in time savings.
- Back-up parameters or software from the drive into PC files. This version allows the entire control board content to be saved and restored later - even to empty control boards.

DriveWindow is part of the Drive<sup>IT</sup> folder of the Industrial<sup>IT</sup>.

## 2.6 Options

### Line reactors

for armature (DCS 60x) and field (DCF 60x) supply

When thyristor power converters operate, the line voltage is short-circuited during commutation from one thyristor to the next. This operation causes voltage dips in the mains. For the connection of a power converter system to the mains, a decision is made between the following configurations:

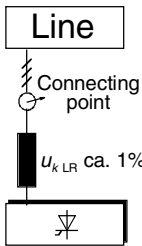

#### Configuration A

When using the power converter, a minimum of impedance is required to ensure proper performance of the snubber circuit. A line reactor can be used to meet this minimum impedance requirement. The value must therefore not drop below 1%  $u_k$  (relative impedance voltage). It should not exceed 10%  $u_k$ , due to considerable voltage drops which would then occur.

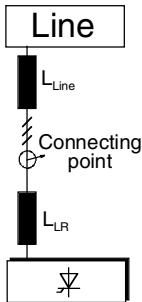

#### Configuration B

If special requirements have to be met at the connecting point, different criteria must be applied for selecting a line reactor. These requirements are often defined as a voltage dip in percent of the nominal supply voltage. The combined impedance of  $Z_{Line}$  and  $Z_{LR}$  constitute the total series impedance of the installation. The ratio between the line impedance and the line reactor impedance determines the voltage dip at the connecting point. In such cases line chokes with an impedance around 4% are often used.

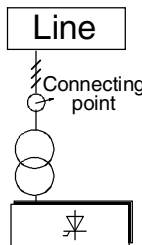

#### Configuration C

If an isolation transformer is used, it is possible to comply with certain connecting conditions per Configuration B without using an additional line reactor. The condition described in Configuration A will then likewise be satisfied, since the  $u_k$  is  $>1\%$ .

#### Configuration C1

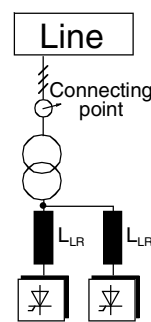

If 2 or more converters should be supplied by one transformer the final configuration depends on the number of drives in use and their power capability. Configuration A or B has to be used which are based on commutation chokes, if the drive system consists of C1, C2 or A5 converters. In case **only two** converters type A6 / A7 (A6 + A6, A6 + A7, A7 + A7) are involved **no** commutation chokes are necessary because the design of these converters is adapted to that wiring.

#### With reference to the power converter:

The line reactors listed in table (2.6/1)

- have been allocated to the units nominal current
- are independent of converter's voltage classification; at some converter types the same line choke is used up to 690 V line voltage
- are based on a duty cycle
- can be used for DCS 600 as well as for DCF 600 converters

You will find further information in publication:  
**Technical Guide chapter: Line reactors**

## Line reactors L1

DCS Type 400V-690V 50/60 Hz	Line choke type for <b>configur. A</b>	Design Fig.	Line choke type for <b>configur. B</b>	Design Fig.
DCS60x-0025-41/51	ND01	1	ND401	4
DCS60x-0050-41/51	ND02	1	ND402	4
DCS60x-0050-61	ND03	1	on request	-
DCS60x-0075-41/51	ND04	1	ND403	5
DCS60x-0100-41/51	ND06	1	ND404	5
DCS60x-0110-61	ND05	1	on request	-
DCS60x-0140-41/51	ND06	1	ND405	5
DCS60x-0200-41/51	ND07	2	ND406	5
DCS60x-0250-41/51	ND07	2	ND407	5
DCS60x-0270-61	ND08	2	on request	-
DCS60x-0350-41/51	ND09	2	ND408	5
DCS60x-0450-41/51	ND10	2	ND409	5
DCS60x-0450-61	ND11	2	on request	-
DCS60x-0520-41/51	ND10	2	ND410	5
DCS60x-0680-41/51	ND12	2	ND411	5
DCS601-0820-41/51	ND12	2	ND412	5
DCS602-0820-41/51	ND13	3	ND412	5
DCS60x-1000-41/51	ND13	3	ND413	5
DCS60x-0903-61/71	ND13	3	on request	-
DCS60x-1203-41/51	ND14	3	on request	-
DCS60x-1503-41/51/61/71	ND15	3	on request	-
DCS60x-2003-41/51	ND16	3	on request	-
DCS601-2003-61/71	ND16 *	3	on request	-

\* with forced cooling

Table 2.6/1: Line reactors (for more information see publication *Technical Data*)

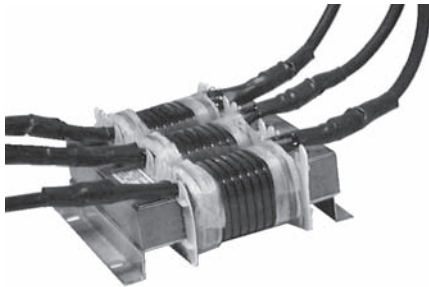

Fig. 1

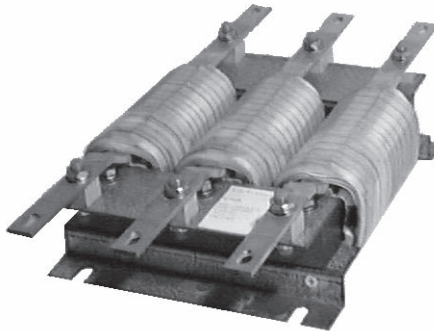

Fig. 2

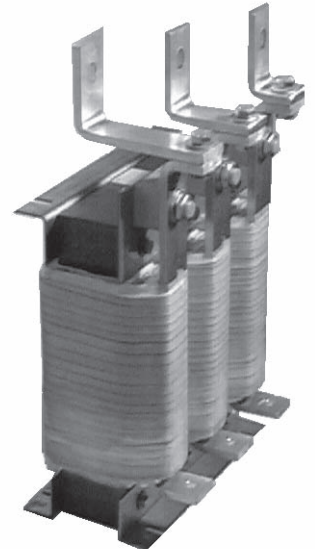

Fig. 3

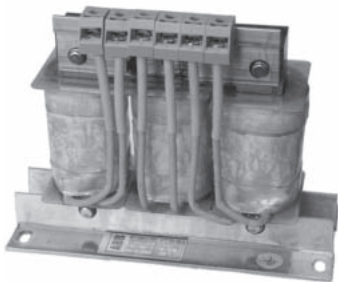

Fig. 4

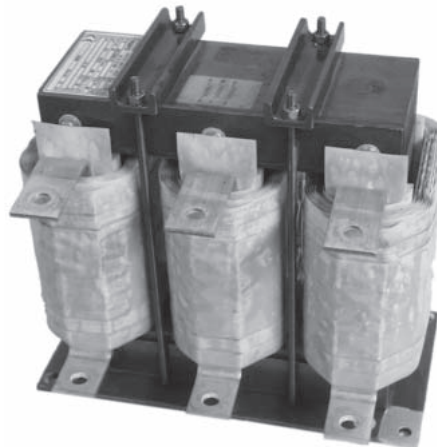

Fig. 5

## Aspects of fusing for the armature-circuit and field supplies of DC drives

### General

#### Unit configuration

Protection elements such as fuses or overcurrent trips are used whenever overcurrents cannot entirely be ruled out. In some configurations, this will entail the following questions: firstly, at what point should which protective element be incorporated? And secondly, in the event of what faults will the element in question provide protection against damage?

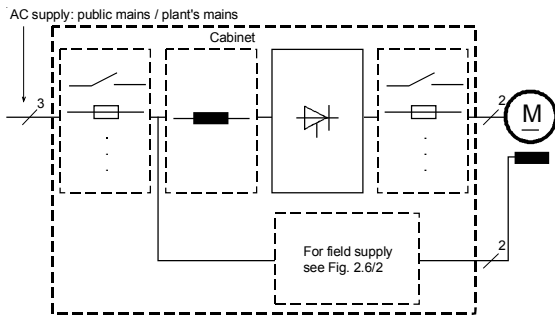

Fig. 2.6/1 Arrangement of the switch-off elements in the armature-circuit converter

You will find further information in publication: **Technical Guide** chapter: *Aspects for fusing*

### Conclusion for the armature supply

Due to cost saving standard fuses are used instead of the more expensive semiconductor fuses at some applications. Under normal and stable operating conditions, this is understandable and comprehensible, as long as **fault scenarios can be ruled out**.

In the **event of a fault**, however, the saving may cause very high consequential costs. Exploding power semiconductor may not only destroy the power converter, but also **cause fires**.

Adequate protection against **short-circuit** and **earth fault**, as laid down in the EN50178 standard, is possible only with **appropriate semiconductor fuses**.

### ABB's recommendations

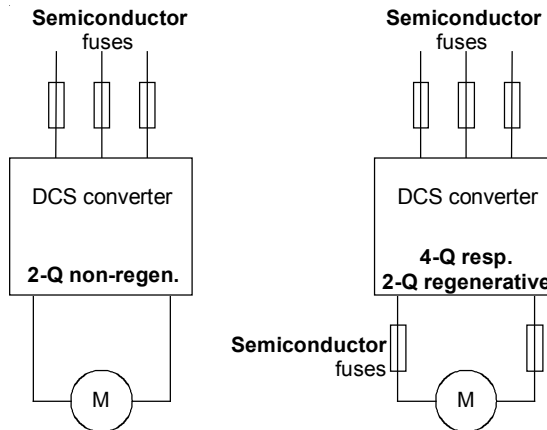

Complies with Basic Principles on:

- |                         |     |
|-------------------------|-----|
| 1 – Explosion hazard    | yes |
| 2 – Earth fault         | yes |
| 3 – “Hard“ networks     | yes |
| 4 – Spark-quenching gap | yes |
| 5 – Short-circuit       | yes |
| 6 – 2Q regenerative     | yes |

## Conclusion for the field supply

Basically, similar conditions apply for both field supply and armature-circuit supply. Depending on the power converter used (diode bridge, half-controlled bridge, fully controlled 4-quadrant bridge), some of the fault sources may not always be applicable. Due to special system conditions, such as supply via an autotransformer or an isolating transformer, new protection conditions may additionally apply.

The following configurations are relatively frequent:

In contrast to the armature-circuit supply, fuses are **never** used on the DC side for the field supply, since a fuse trip might under certain circumstances lead to greater damage than would the cause tripping the fuse in the first place (small, but long-lasting overcurrent; fuse ageing; contact problems; etc.).

Semiconductor fuse F3.1 (super-fast acting) should be used, if conditions similar to those for armature-circuit supply are to apply, like for example protection of the field supply unit and the field winding.

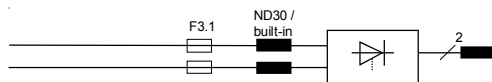
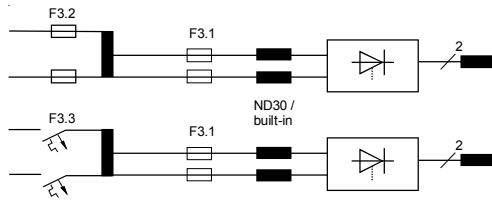

Fig 2.6/2 Configuration for field supplies

The F3.2 and F3.3 fuse types serve as line protectors and **cannot protect the field supply unit**. Only pure HRC fuses or miniature circuit-breakers may be used. Semiconductor fuses would be destroyed, for example, by the transformer's starting current inrush.



FF\_ASP\_b.dsf

Fig 2.6/3 Configurations for field supplies

## Semiconductor type F1 fuses and fuse holders for AC and DC power lines (DCS 601 /DCS 602 - DCF 601/DCF 602)

The converter units are subdivided into two groups:

- Unit sizes C1 and C2 with rated currents up to 1000 A require external fuses.
- In unit sizes A5, A6 and A7 with rated currents of 900 A to 5200 A, the semiconductor fuses are installed internally (no additional external semiconductor fuses are needed).

The table on the right assigns the AC fuse type to the converter type. In case the converter should be equipped with DC fuses according to the hints use the same type of fuse used on the AC side now in the plus and minus line. Blade type fuses are used for all the converters construction type C1 and C2 except the biggest one.

Type of converter	Type	Fuse holder
DCS60x-0025-41/51	170M 1564	OFAX 00 S3L
DCS60x-0050-41/51	170M 1566	OFAX 00 S3L
DCS60x-0050-61	170M 1566	OFAX 00 S3L
DCS60x-0075-41/51	170M 1568	OFAX 00 S3L
DCS60x-0100-51	170M 3815	OFAX 1 S3
DCS60x-0110-61	170M 3815	OFAX 1 S3
DCS60x-0140-41/51	170M 3815	OFAX 1 S3
DCS60x-0200-41/51	170M 3816	OFAX 1 S3
DCS60x-0250-41/51	170M 3817	OFAX 1 S3
DCS60x-0270-61	170M 3819	OFAX 1 S3
DCS60x-0350-41/51	170M 5810	OFAX 2 S3
DCS60x-0450-41/51/61	170M 6811	OFAS B 3
DCS60x-0520-41/51	170M 6811	OFAS B 3
DCS60x-0680-41/51	170M 6813	OFAS B 3
DCS60x-0820-41/51	170M 6813	OFAS B 3
DCS60x-1000-41/51	170M 6166	3x 170H 3006

Table 2.6/2: Fuses and fuse holders (details see *Technical Data*)

## Fuses F3.x and fuse holders for 2-phase field supply

Depending on the protection strategy different types of fuses are to be used. The fuses are sized according to the nominal current of the field supply device. If the field supply unit is connected to two phases of the network, two fuses should be used; in case the unit is connected to one phase and neutral only one fuse at the phase can be used. Table 2.6/3 lists the fuses currents with respect to table 2.6/2.

The fuses can be sized according to the maximum field current. In this case take the fuse, which fits to the field current levels.

Field conv.	Field current	F3.1	F3.2	F 3.3
SDCS-FEX-1 SDCS-FEX-2A	$I_F \leq 6 \text{ A}$	170M 1558	OFAA 00 H10	10 A
SDCS-FEX-2A	$I_F \leq 12 \text{ A}$	170M 1559	OFAA 00 H16	16 A
SDCS-FEX-2A DCF 503A DCF 504A	$I_F \leq 16 \text{ A}$	170M 1561	OFAA 00 H25	25 A
DCF 503A DCF 504A	$I_F \leq 30 \text{ A}$	170M 1564	OFAA 00 H50	50 A
DCF 503A DCF 504A	$I_F \leq 50 \text{ A}$	170M 1565	OFAA 00 H63	63 A
<b>Type of protection elements</b>		Semiconduct. type fuse for fuse holder type OFAX 00	LV HRC type for 690 V; fuse hold. OFAX 00	circuit breaker for 500 V or 690 V

Table 2.6/3: Fuses and fuse holders for 2-phase field supply

## Transformer T3 for field supply to match voltage levels

The field supply units' insulation voltage is higher than the rated operating voltage (see Chapter *Field supplies*), thus providing an option in systems of more than 500 V for supplying the power section of the converter directly from the mains for purposes of armature supply, and using an autotransformer to match the field supply to its rated voltage. Moreover, you can use the autotransformer to adjust the field voltage (SDCS-FEX-1 diode bridge) or to reduce the voltage ripple. Different types (primary voltages of 400...500 V and of 525...690 V) with different rated currents each are available.

Field converter type $\leq 500 \text{ V}; 50/60 \text{ Hz}$	for field current $I_F$	Transformer type 50/60 Hz
SDCS-FEX-1 SDCS-FEX-2A SDCS-FEX-2A DCF503A/4A-0050 DCF503A/4A-0050	$\leq 6 \text{ A}$ $\leq 12 \text{ A}$ $\leq 16 \text{ A}$ $\leq 30 \text{ A}$ $\leq 50 \text{ A}$	$U_{\text{prim}} = \leq 500 \text{ V}$ T 3.01 T 3.02 T 3.03 T 3.04 T 3.05
SDCS-FEX-1 SDCS-FEX-2A SDCS-FEX-2A	$\leq 6 \text{ A}$ $\leq 12 \text{ A}$ $\leq 16 \text{ A}$	$U_{\text{prim}} = \leq 600 \text{ V}$ T 3.11 T 3.12 T 3.13
DCF503A/4A-0050 DCF503A/4A-0050	$\leq 30 \text{ A}$ $\leq 50 \text{ A}$	$U_{\text{prim}} = \leq 690 \text{ V}$ T 3.14 T 3.15

Table 2.6/4: Autotransformer data (details see *Technical Data*)

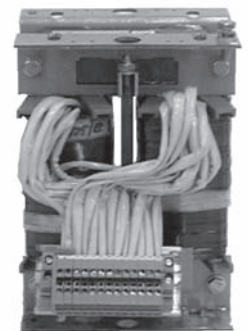

Fig. 2.6/4: T3 autotransformer

## Commutating reactor

When using the SDCS-FEX-2A field power converter, you should additionally use a commutating reactor because of EMC considerations. A commutating reactor is not necessary for the SDCS-FEX-1 (diode bridge). With DCF 503A/504A field power converters, it is already installed.

Converter	Reactor
≤500 V; 50/60 Hz	
SDCS-FEX-2A	ND 30

Table 2.6/4: Commutating reactor (for more information see publication *Technical Data*)

## Auxiliary transformer T2 for electronic system / fan supply

The converter unit requires various auxiliary voltages, e.g. the unit's electronics require 115 V/1-ph or 230 V/1-ph, the unit fans require 230 V/1-ph or 400 V/690 V/3-ph, according to their size. The T2 auxiliary transformer is designed to supply the unit's electronic system and all the single-phase fans including the fan of the A5 converter.

Input voltage: 380...690 V/1-ph; 50/60 Hz

Output voltage: 115/230 V/1-ph

Power: 1400 VA



Fig. 2.6/5: T2 auxiliary transformer

## Residual current detection

This function is provided by the standard software. If needed, the analogue input AI4 has to be activated, a current signal of the three phase currents should be supplied to AI4 by a current transformer. If the addition of the three current signal is different from zero, a message is indicated (for more information, see publication *Technical Data*).



## EMC filters

You will find further information in publication:

### Technical Guide

chapter: *EMC Compliant Installation and Configuration for a Power Drive System*

The paragraphs below describe selection of the electrical components in conformity with the EMC Guideline.

The aim of the EMC Guideline is, as the name implies, to achieve electromagnetic compatibility with other products and systems. The guideline ensures that the emissions from the product concerned are so low that they do not impair another product's interference immunity.

In the context of the EMC Guideline, two aspects must be borne in mind:

- the product's **interference immunity**

- the product's actual **emissions**

The EMC Guideline expects EMC to be taken into account when a product is being developed; however, EMC cannot be designed in, it can only be quantitatively measured.

### Note on EMC conformity

The conformity procedure is the responsibility of both the power converter's supplier and the manufacturer of the machine or system concerned, in proportion to their share in expanding the electrical equipment involved.

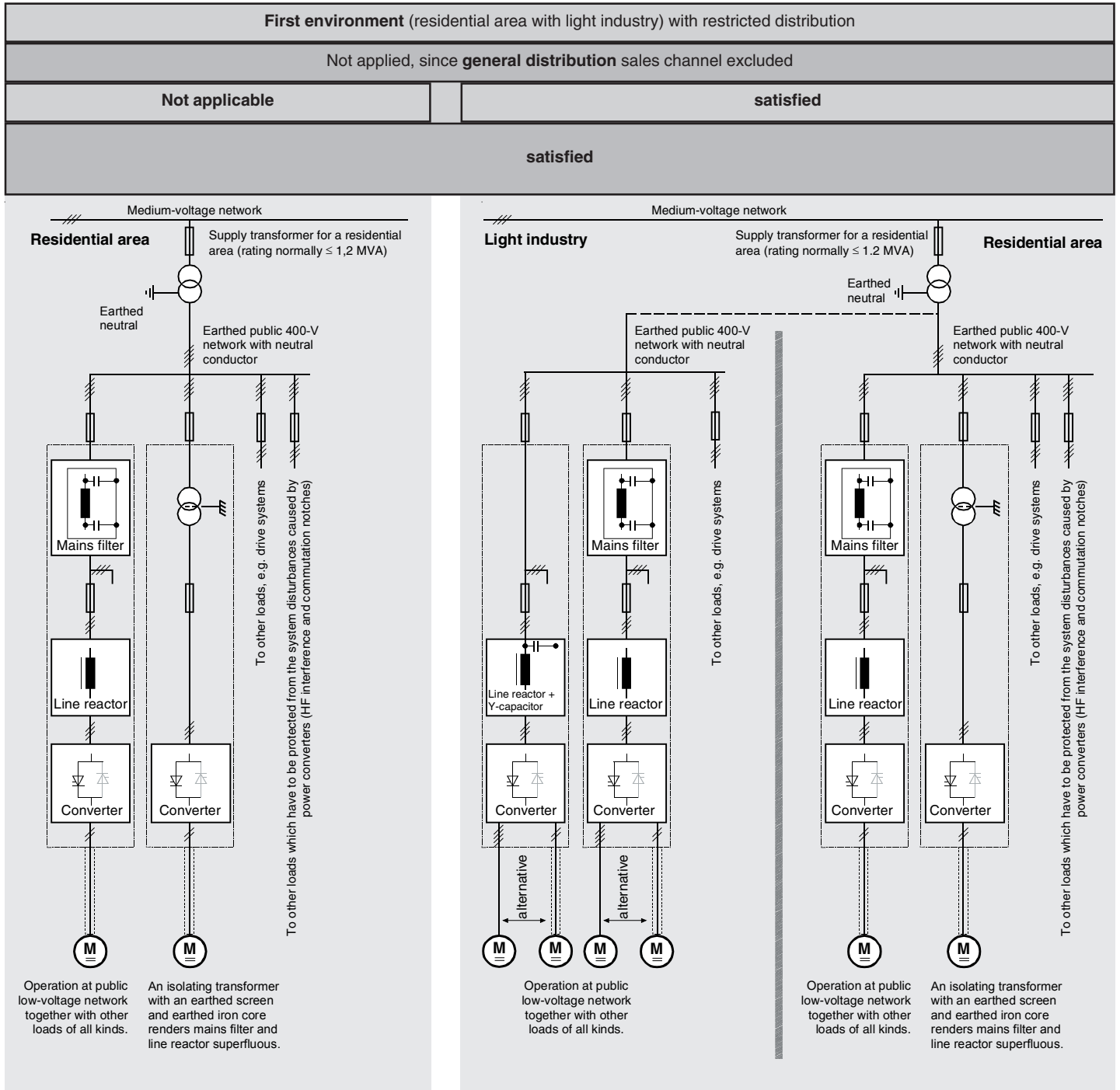

Fig. 2.6/5: Classification

For compliance with the protection objectives of the German EMC Act (EMVG) in systems and machines, the following EMC standards must be satisfied:

**Product Standard EN 61800-3**

EMC standard for drive systems (PowerDriveSystem), interference immunity and emissions in residential areas, enterprise zones with light industry and in industrial facilities.

This standard must be complied with in the EU for satisfying the EMC requirements for systems and machines!

For emitted interference, the following apply:

**EN 61000-6-3** Specialised basic standard for emissions in **light industry** can be satisfied with special features (mains filters, screened power cables) in the lower rating range \*(EN 50081-1).

**EN 61000-6-4** Specialised basic standard for emissions in **industry** \*(EN 50081-2)

For interference immunity, the following apply:

**EN 61000-6-1** Specialised basic standard for interference immunity in **residential areas** \*(EN 50082-1)

**EN 61000-6-2** Specialised basic standard for interference immunity in **industry**. If this standard is satisfied, then the EN 61000-6-1 standard is automatically satisfied as well \*(EN 50082-2).

\* The generic standards are given in brackets

<b>Second environment (industry) with restricted distribution</b>		
<b>Not applicable</b>		
<b>satisfied</b>	<b>on customer's request</b>	<b>satisfied</b>
<b>satisfied</b>		

Standards	Classification
EN 61800-3	The following overview utilises the terminology and indicates the action required in accordance with Product Standard EN 61800-3. For the DCS 500B series, the limit values for emitted interference are complied with, provided the action indicated is carried out. This action is based on the term <i>Restricted Distribution</i> used in the standard (meaning a sales channel in which the products concerned can be placed in the stream of commerce only by suppliers, customers or users which individually or jointly possess technical EMC expertise).
EN 61000-6-3	
EN 61000-6-4	
EN 61000-6-2	
EN 61000-6-1	

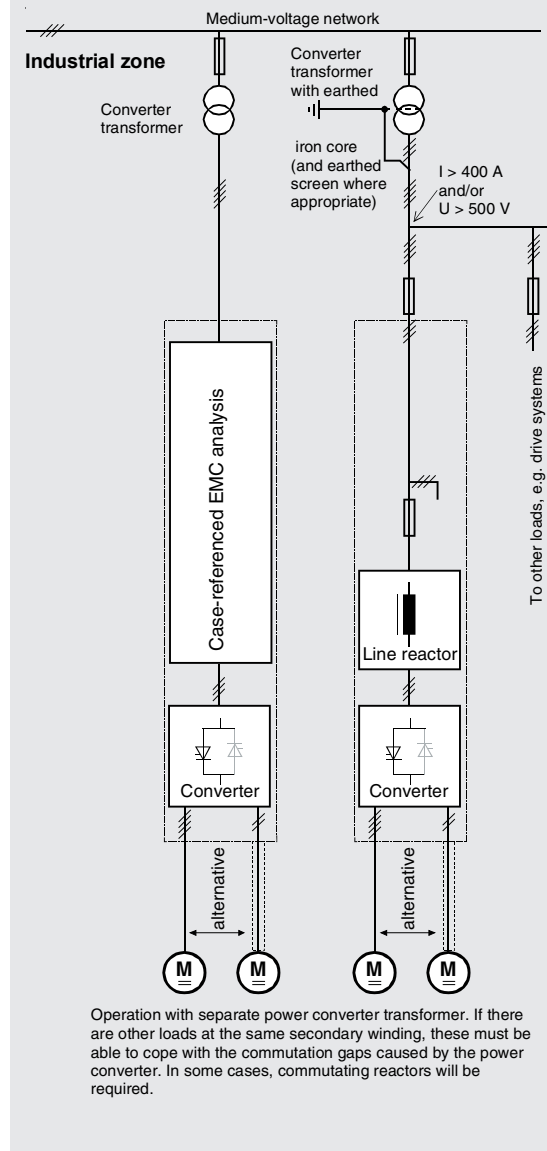
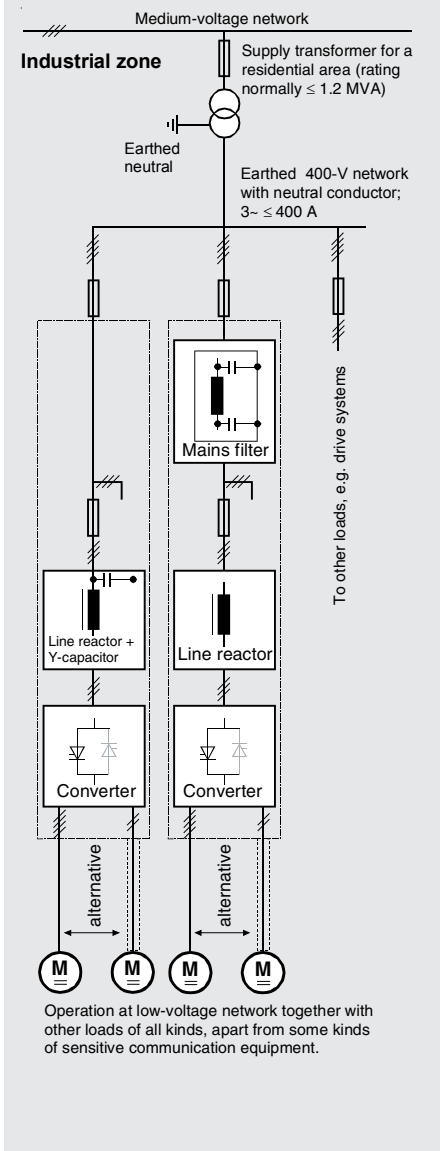

For power converters without additional components, the following warning applies:

This is a product with restricted distribution under IEC 61800-3. This product may cause radio interference in residential areas; in this case, it may be necessary for the operator to take appropriate action (see adjacent diagrams).

The field supply is not depicted in this overview diagram. For the field current cables, the same rules apply as for the armature-circuit cables.

Legend	
	Screened cable
	Unscreened cable with restriction

### Filter in a grounded line (earthed TN or TT network)

The filters are suitable for grounded lines only, for example in public European 400 V lines. According to EN 61800-3 filters are not needed in insulated industrial lines with own supply transformers. Furthermore they could cause safety risks in such floating lines (IT networks).

### Three - phase filters

EMC filters are necessary to fulfil the standard for emitted interference if a converter shall be run at a public low voltage line, in Europe for example with 400 V between the phases. Such lines have a grounded neutral conductor. ABB offers suitable three - phase filters for 400 V and 25 A...600 A and 500 V filters for 440 V lines outside Europe.

The filters can be optimized for the real motor currents:

$$I_{\text{Filter}} = 0.8 \cdot I_{\text{MOT max}}$$

; the factor 0.8 respects the current ripple.

Lines with 500 V to 1000 V are not public. They are local lines inside factories, and they do not supply sensitive electronics. Therefore converters do not need EMC filters if they shall run with 500 V and more.

Converter	I <sub>dc</sub> [A]	Const. type	Filter type for y=4	Filter type for y= 5	Filter type for y=6 or 7
DCS60x-0025-y1	25A	C1a	NF3-440-25	NF3-500-25	---
DCS60x-0050-y1	50A	C1a	NF3-440-50	NF3-500-50	---
DCS60x-0075-y1	75A	C1a	NF3-440-64	NF3-500-64	---
DCS60x-0100-y1	100A	C1b	NF3-440-80	NF3-500-80	---
DCS60x-0140-y1	140A	C1b	NF3-440-110	NF3-500-110	---
DCS60x-0200-y1	200A	C2a	NF3-500-320	NF3-500-320	---
DCS60x-0250-y1	250A	C2a	NF3-500-320	NF3-500-320	---
DCS60x-0270-61	250A	C2a	NF3-500-320	NF3-500-320	NF3-690-600 ①
DCS60x-0350-y1	350A	C2a	NF3-500-320	NF3-500-320	---
DCS60x-0450-y1	450A	C2a	NF3-500-600	NF3-500-600	NF3-690-600 ①
DCS60x-0520-y1	520A	C2a	NF3-500-600	NF3-500-600	---
DCS60x-0680-y1	680A	C2b	NF3-500-600	NF3-500-600	---
DCS601-0820-y1	740A	C2b	NF3-500-600	NF3-500-600	---
DCS602-0820-y1	820A	C2b	NF3-690-1000 ①	NF3-690-1000 ①	---
DCS60x-1000-y1	1000A	C2b	NF3-690-1000 ①	NF3-690-1000 ①	---
DCS60x-0903-y1	900A	A5	NF3-690-1000 ①	NF3-690-1000 ①	NF3-690-1000 ①
DCS60x-1203-y1	1200A	A5	NF3-690-1000 ①	NF3-690-1000 ①	NF3-690-1000 ①
DCS60x-1503-y1	1500A	A5	NF3-690-1600 ①	NF3-690-1600 ①	NF3-690-1600 ①
DCS60x-2003-y1	2000A	A5	NF3-690-1600 ①	NF3-690-1600 ①	NF3-690-1600 ①
	≤ 3000A	A6	NF3-690-2500 ①	NF3-690-2500 ①	NF3-690-2500 ①

① Filter only available on request

### Single - phase filters for field supply

Many field supply units are single - phase converters for up to 50 A excitation current. They can be supplied by two of the three input phases of the armature supply converter. Then a field supply unit does not need its own filter.

If the phase to neutral voltage shall be taken (230 V in a 400 V line) then a separate filter is necessary. ABB offers such filters for 250 V and 6...30 A.

Converter type of field supply unit	dc current [A]	Filter type ① U <sub>max</sub> = 250 V
SDCS-FEX-1	6	NF1-250-8
SDCS-FEX-2A	8	NF1-250-8
SDCS-FEX-2A	16	NF1-250-20
DCF 503A-0050	50	NF1-250-55
DCF 504A-0050	50	NF1-250-55
further filters for	12	NF1-250-12
	30	NF1-250-30

① The filters can be optimized for the real field currents:  $I_{\text{Filter}} = I_{\text{Field}}$

# 3 Overview of software (Version 15.xxx)

## 3.1 Basic structure of DCS 600 MultiDrive

The control hardware of DCS 600 MultiDrive consists of 2 parts:

- converter control board SDCS-CON-2
- drive control board SDCS-AMC-DC 2 (AMC = Application Motor Control)

Accordingly, the software is split into 2 parts:

- All control functions superimposed to the torque reference are done inside the AMC board. In addition, all HMI (Human Machine Interface) and communication functions are part of the AMC board's software. Also the Start/Stop functions ('Drive Logic') are realized by the AMC board's software. All parameters and signals of the drive are accessed via an on the AMC board residing data structure called 'AMC-table'.
- All converter related functions and the handling of standard I/O are done by the SDCS-CON-2 software:
  - Armature current control
  - Field weakening
  - Motor protection
  - I/O handling

In general, the software functions are distributed between the SDCS-CON-2 board and the SDCS-AMC-DC 2 board according to the following diagram:

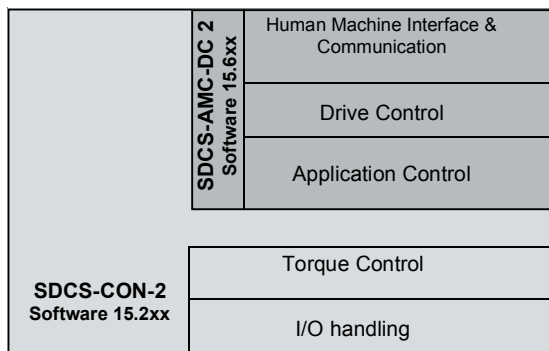

Fig. 3.1/1: Distribution of software functions

## 3.2 Control Modes

The Control mode selects the source of control word and references.

### Local Mode

Commissioning tool DriveWindow is connected to DDCS channel 3 of the AMC board and can use local mode. Local mode is also available on the panel CDP 312.

### Remote Mode

Reference and control word are supplied by an overriding control system or a fieldbus adapter connected to the DDCS channel 0.

### Master/Follower Mode

Reference and control word are supplied to the follower drive by the master drive via DDCS channel 2.

### 3.3 Start, Stop and Fault Reactions

During operation, the drive is in one of the following states (ABB Drive profile):

ON_INHIBIT	After emergency stop (OFF3_N) or emergency off (OFF2_N) this state is entered until ON = 0
OFF	Main contactor is off, OFF3_N or OFF2_N active
RDY_ON	Main contactor is off
RDY_RUN	Main, field and fan contactor are closed, field control activated, ready for run command
RDY_REF	Drive is running, all controllers are released
TRIPPED	Drive is faulted
OFF_2_STA_N	Drive is coasting due to emergency off command; the states ZERO_A_AND_F → ONINHIBIT are entered.
OFF_3_STA_N	Drive stops according to the programmed emergency stop ramp and the programmed emergency stop mode; at zero speed, the state ON_INHIBIT is entered.

Table 3.1/1: States of the drive

#### Power up

When the electronics power supply is switched on the drive stays in the ON\_INHIBIT state until ON = 0 is detected. In case of a fault the drive stays in the FAULT state.

#### Normal start

Status bit RDY\_ON = 1 signals that no faults are pending and that the device is ready to close the main, fan and field contactor.

A rising edge of the ON command closes fan, field and main contactor and activates the field control.

Status bit RDY\_RUN = 1 indicates that the field converter is active and that the drive is ready to generate torque.

A rising edge of the RUN command activates speed and torque control.

Status bit RUNNING = 1 indicates that the drive is in normal operation.

#### Normal stop

RUN = 0 sets the speed reference to zero and the drive decelerates.

After the actual speed has reached zero the status bit RUNNING is reset, the armature converter sets the firing angle to maximum. The state RDY\_RUN is entered, when the actual current has reached zero.

ON = 0 sets RDY\_RUN = 0 and the field current reference to zero. The field converter sets the firing angle to maximum. The contactors are opened, when the actual current has reached zero.

ON = 0 internally forces RUN = 0.

#### Emergency off

Field and armature current are removed as fast as possible. After the current has reached  $I_{DC} = 0$  the contactors are opened. The normal start command is accepted when OFF2\_N = EME\_OFF\_N = 1.

#### Emergency stop

Command EME\_STOP = 0 gives the same procedure as RUN = 0 (normal stop) except that the ramp is switched from deceleration to emergency stop and the state ON\_INHIBIT is entered when the speed has reached zero.

The normal start command is accepted when OFF3\_N = EME\_STOP\_N = 1.

The reference handling and current limitation is controlled by EME\_STOP\_MODE.

#### Fault reaction

Depending on the actual fault the armature current and/or field current is reduced to zero as fast as possible with single pulses and maximum firing angle. Contactors are opened when the current has reached zero.

Then the state TRIPPED is entered and after a successful reset the state ON\_INHIBIT.

The following state diagram shows the transitions between the different states.

# ABB Drive Profile for DC-drives Control and Status

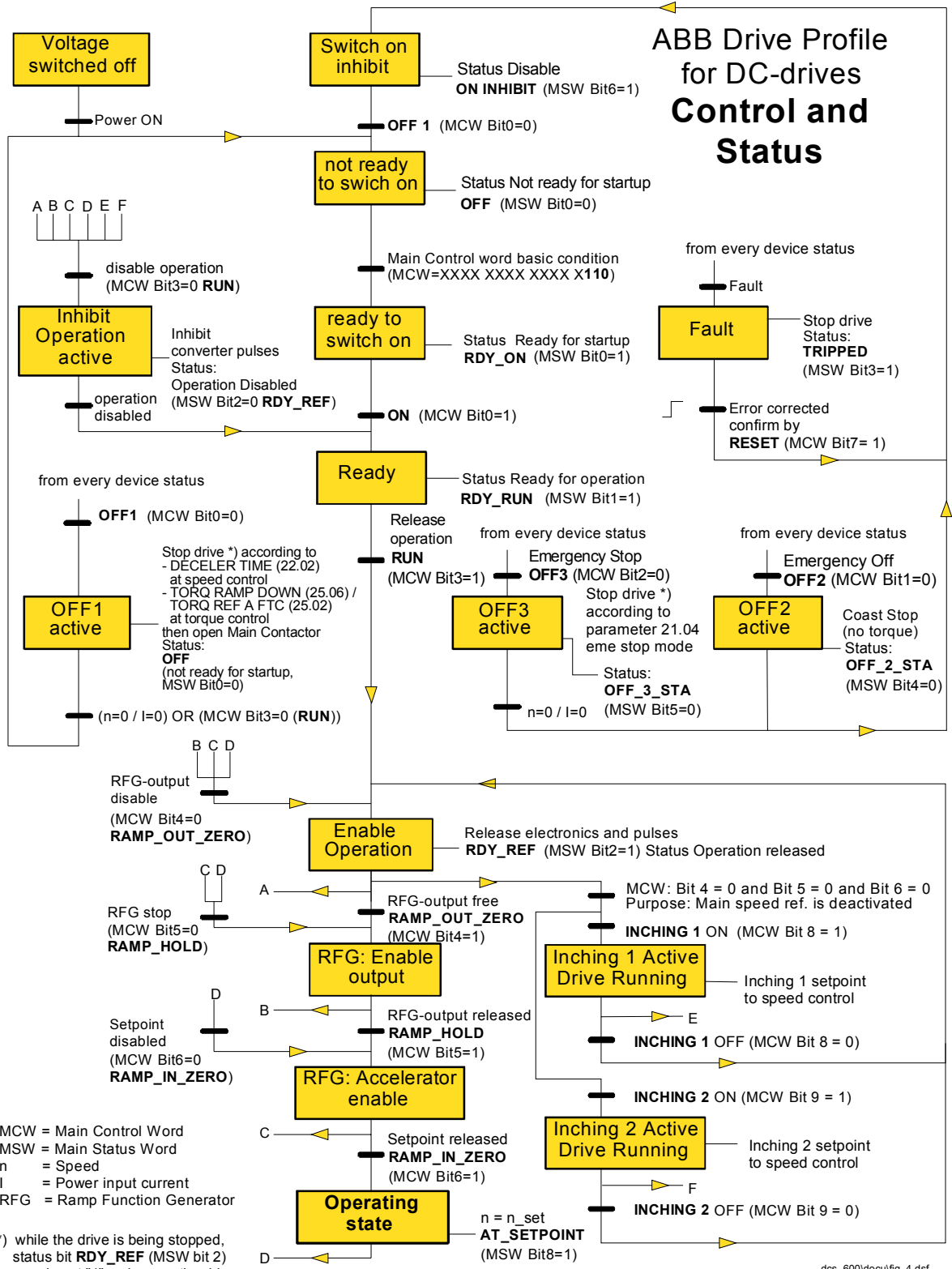

Fig. 3.3/1: Control and status

### 3.4 Speed Control

The speed controller is located in the AMC board software.

#### Speed reference

The source of the reference is depending on the operating mode.

Overriding control system, fieldbus adapters	→ remote mode, DDCS via AMC board
DriveWindow	→ local mode, DDCS via AMC board
Panel CDP312	→ local mode, connector on CON-2
Analogue inputs	→ local I/O

#### Speed reference features

- Speed reference limiter
- Additional speed ramp for emergency stop
- Variable slope rate
- Speed correction
- Reference for inching before the ramp
- 2 different references for inching behind the ramp

#### Speed measurement

The actual speed may be calculated from:

- Armature voltage
- Analogue tachometer
- Pulse encoder

#### Controller features

- PID controller
- 2 first order low pass filters
- Window control
- Acceleration compensation
- Speed and torque adaptation
- Droop
- Additional torque references
- Torque limitation and gear backlash function (the integral part of the controller is set to a suitable value on limitation)
- Oscillation damping (band rejection filter for speed error)

The diagram Fig. 3.8/2 shows the functionality of the speed reference chain as well as of the speed controller.

### 3.5 Torque Control

#### Flux and Torque Calculation

The torque control is in general an open loop control. The flux is adjusted by the field current. The reference of the field current is generated by the superimposed armature voltage control.

The torque is adjusted by the armature current. The conversion from torque to current reference is done by means of the calculated flux (based on the field current and saturation characteristic).

#### Torque reference features

- Torque reference A with 1st order filter and load share
- Torque reference B with torque ramp
- Torque reference limiter
- Torque correction and torque step
- Torque correction by means of analogue input 1

A good behaviour in the field weakening requires speed measurement by tachometer or encoder.

A simplified scheme of the torque reference chain is given in diagram fig. 3.8/2.

### 3.6 HMI (Human Machine Interface)

The HMI is performed by CDP 312 control panel or by DriveWindow.

Both tools contain:

- Display of drive signals
- Setting of drive parameters
- Display fault and alarm messages
- Control the drive in local operation

## 3.7 Torque Generation

### Interface between SDCS-AMC-DC 2 board and DC control board SDCS-CON-2

The major signals exchanged each 2 ms between CON-2 and AMC-DC 2 are:

**SPEED\_ACTUAL** speed actual value from CON-2  
**TORQ\_USED\_REF** active torque reference to CON-2

In addition, the calculated torque limits are read from the CON-2 each 8 ms:

**TC\_TORQMAX**  
**TC\_TORQMIN**

The addition of the torque correction TQ\_CORR from an analogue input of CON-2 is done by the CON-2 software.

### Armature voltage Control

This controller enables operation in the field weakening range. It generates the field current reference. At low speeds the field current is constant and armature voltage is roughly proportional to the speed. At higher speeds ( $\geq$  base speed) the field current reference is reduced so that the armature voltage doesn't exceed its reference.

### Field Current Control

Two field exciters can be operated simultaneously for two different motors.

The first field exciter can be operated with fixed current reference, in field weakening or with a reduced reference for field heating.

The second field exciter has a fixed current reference (no field weakening possible). However, it may be reduced for field heating purposes.

A field reversal control is available for the first field exciter.

Optitorque is a special control method where the flux is reduced at small torque reference. This is available for drives with and without field reversal.

### Armature Current Control

The armature current reference is calculated from torque reference and flux. Then it is processed by a ramp, limitation and speed dependent limitation.

The actual value of the armature current is the measured mean value between two firing pulses.

The armature voltage reference is generated by a PI controller.

The firing angle is calculated from this voltage reference depending on the actual line voltage and the conduction time (adaptation between continuous and discontinuous state of the converter current).

A simplified scheme of the armature current control is given in diagram fig. 3.8/3.

### 3.8 Software diagrams

#### Introduction

The designation of parameters and signals consist of a group and a index.

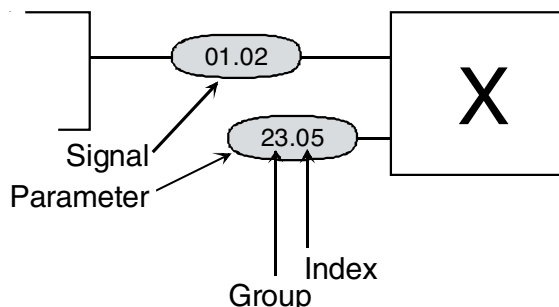

Fig. 3.8/1: Parameter/signal designation

The structure of the software is given. Changes of the functions or pointers are realized through setting parameters.

This can be done via panel, DriveWindow (PC utility), fieldbus or overriding control system.

Changed parameters or pointers are stored immediately in the non-volatile flash PROM.

All parameters can be transferred to the PC and be stored on a data medium by using DriveWindow.

On the following pages the simplified software structure is shown. Additionally there are specific tables for:

- **Main Control Word (MCW)**
- **Auxiliary Control Words (ACW)**
- **Main Status Word (MSW)**
- **Auxiliary Status Word (ASW)**
- **Digital Inputs** (Armature converter mode)
- **Digital Inputs** (Field converter mode)
- **Digital Outputs** (Armature converter mode)
- **Digital Outputs** (Field converter mode)
- **Analogue Inputs** (Armature converter mode)

# SPEED REFERENCE CHAIN

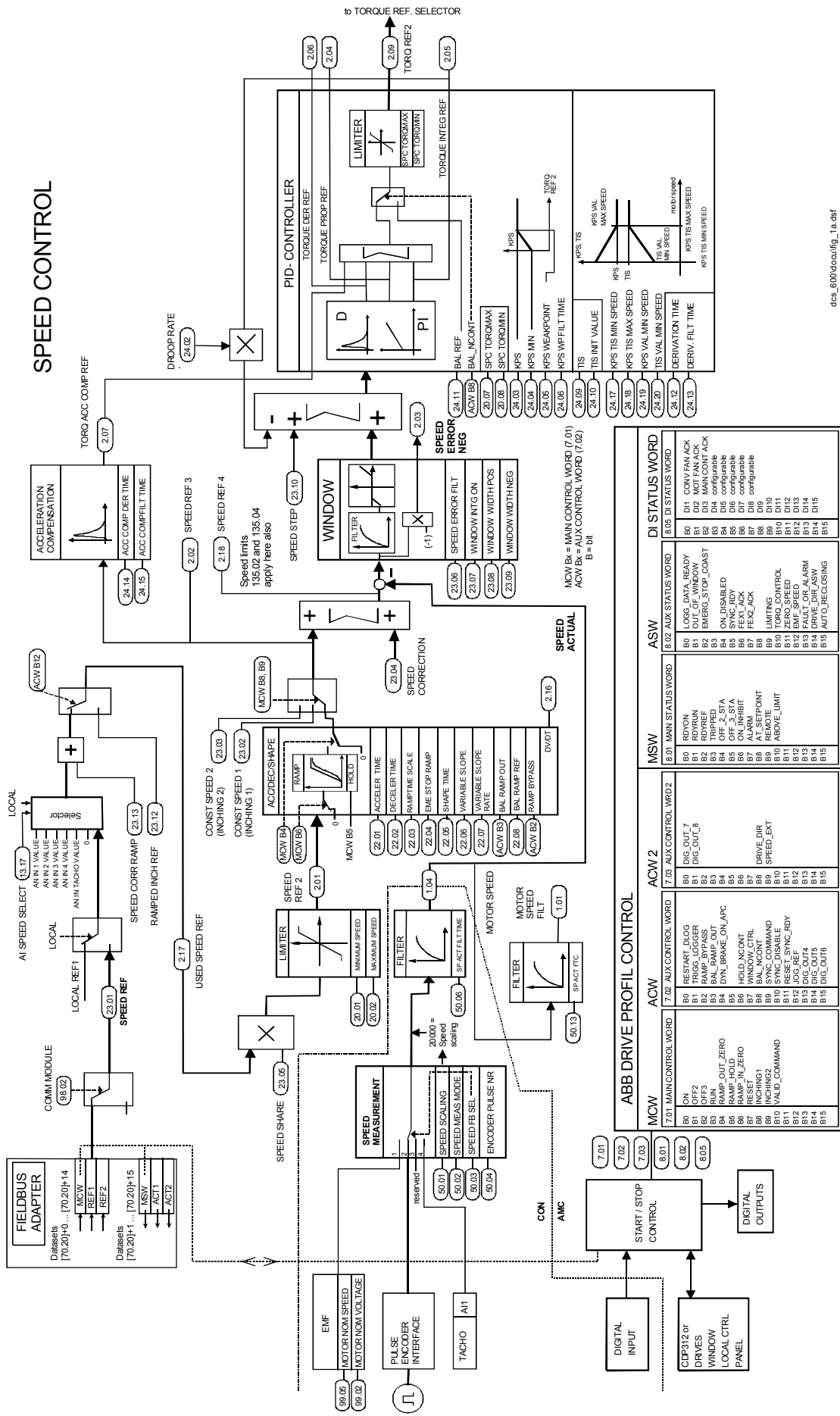

dcs\_600docu\_fg\_1a.dsf

Fig. 3.8/2: Speed reference chain

# TORQUE CONTROL CHAIN

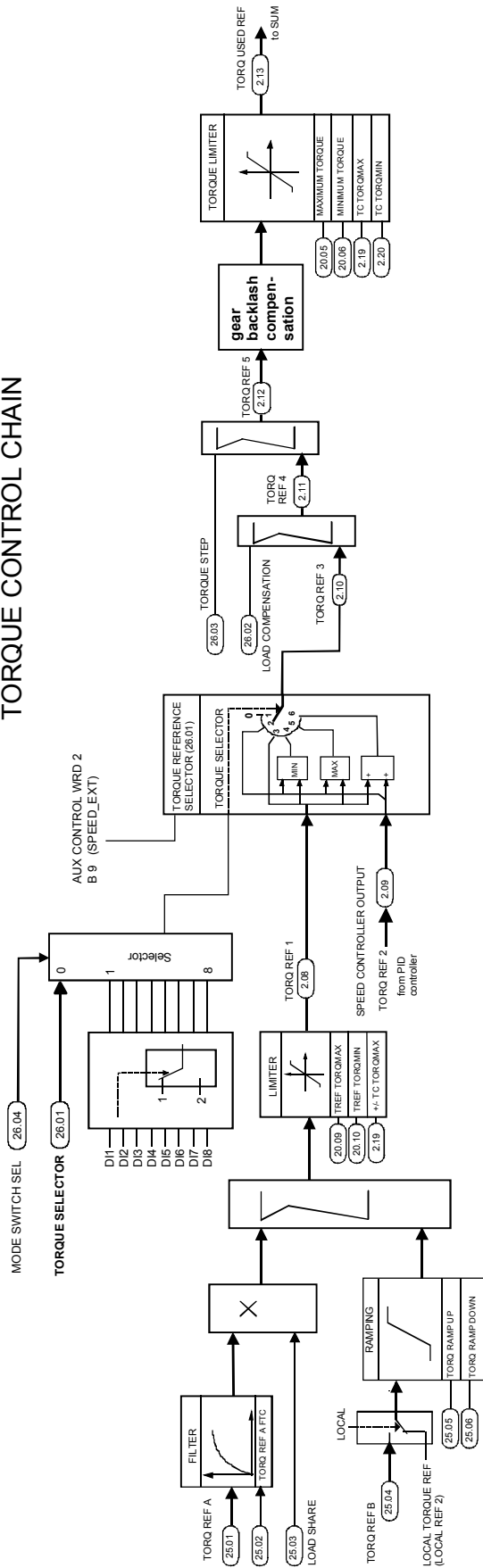

AMC

CON

## Analogue outputs

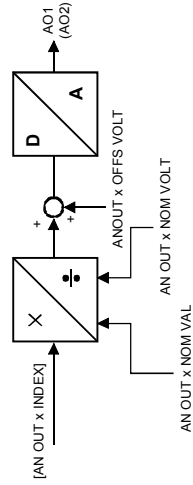

AN OUT 1 INDEX	14.04
AN OUT 1 NOM VAL	14.03
AN OUT 1 OFFS VOLT	14.02
AN OUT 1 NOM VOLT	14.01
AN OUT 2 INDEX	14.08
AN OUT 2 NOM VAL	14.07
AN OUT 2 OFFS VOLT	14.06
AN OUT 2 NOM VOLT	14.05

## Analogue inputs

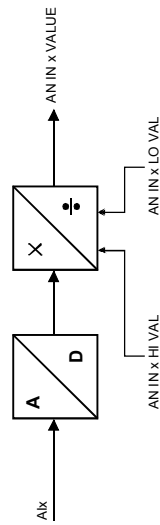

AN IN 3 VALUE (signal)	5.04
AN IN 3 HI VAL (at +10V)	13.07
AN IN 3 LO VAL (at -10V)	13.08
AN IN 4 VALUE (signal)	5.05
AN IN 4 HI VAL (at +10V)	13.09
AN IN 4 LO VAL (at -10V)	13.10

AN IN TACHO VALUE (signal)	5.01
AN IN TACH HI VAL (at +10V)	13.01
AN IN TACH LO VAL (at -10V)	13.02
AN IN 1 VALUE (signal)	5.02
AN IN 1 HI VAL (at +10V)	13.03
AN IN 1 LO VAL (at -10V)	13.04
AN IN 2 VALUE (signal)	5.03
AN IN 2 HI VAL (at +10V)	13.05
AN IN 2 LO VAL (at -10V)	13.06

dcs\_600/docu/fig\_2a.dsf

Fig. 3.8/3: Torque control chain

# ARMATURE CURRENT CONTROL

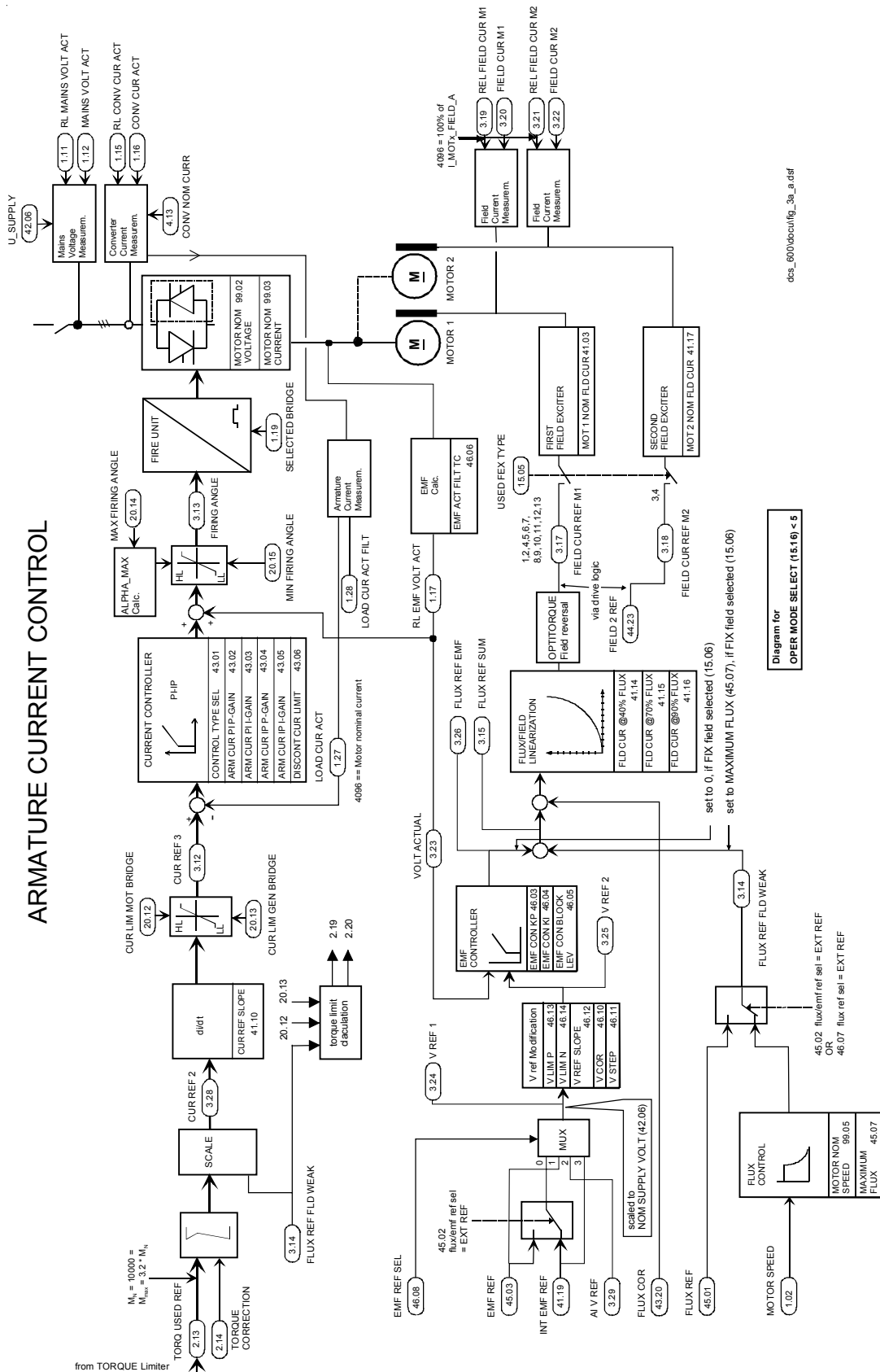

dcs\_600docu\fig\_3a\_a.dsf

Diagram for OPER MODE SELECT (15.16) < 5

Fig. 3.8/4: Armature current control

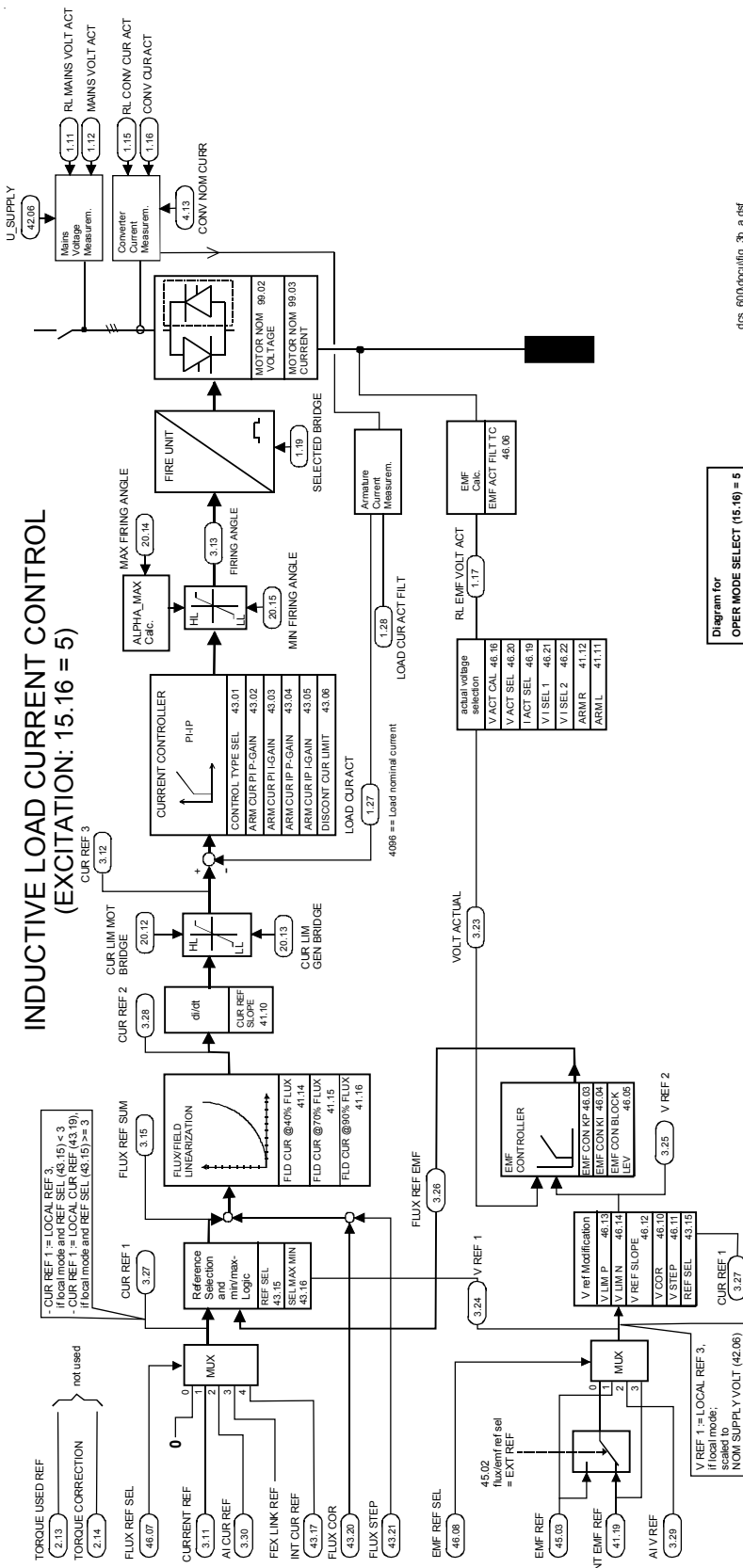

dcs\_600.doc\fig\_3b\_9.dxf

Fig. 3.8/5: Inductive load current control

## Control and Status Words

In remote mode, the drive is controlled by the main control word and the auxiliary control words. The drive's status is read from the main status word and the auxiliary status word.

Main Control Word (7.01)		
Bit	Name	Function
0	ON (OFF1_N)	start fans, field and close main contactor
1	OFF2_N	coast stop
2	OFF3_N	reserved for emergency stop
3	RUN	run with selected reference
4	RAMP_OUT_ZERO	Speed ramp output is forced to zero
5	RAMP_HOLD	Speed ramping is stopped
6	RAMP_IN_ZERO	Speed ramp input is forced to zero
7	RESET	acknowledge a fault indication
8	INCHING_1	Constant speed 1 (23.2) selected
9	INCHING_2	Constant speed 2 (23.3) selected
10	VALID_COMMAND	0: Freeze main control word 1: Main control word is valid
11	reserved	(reserved)
12	reserved	(reserved)
13	reserved	(reserved)
14	reserved	(reserved)
15	reserved	(reserved)

Table 3.8/1: Main Control Word

Auxiliary Control Word (7.02)		
Bit	Name	Function
0	RESTART_DLOG	Restart of data logger (not available)
1	TRIG_LOGGER	Data logger triggering
2	RAMP_BYPASS	Speed ramp is bypassed
3	BAL_RAMP_OUT	Forcing of ramp output
4	DYN_BRAKE_ON_-APC	activate dynamic braking
5	reserved	(reserved)
6	HOLD_NCONT	Holding of the speed controller's integrator
7	WINDOW_CTRL	Window control activated
8	BAL_NCONT	Forcing of speed controller's output
9	SYNC_COMMAND	synchronising command
10	SYNC_DISABLE	synchronising is disabled
11	RESET_SYNC_RDY	reset synchronised ready
12	RAMPED_INCH_REF	Switch speed ramp input to RAMPED INCH REF (23.12)
13	DIG_OUT4 (14.11)	digital output 4
14	DIG_OUT5 (14.14)	digital output 5
15	DIG_OUT6 (14.17)	digital output 6

Table 3.8/2: Auxiliary Control Word

Auxiliary Control Word 2 (7.03)		
Bit	Name	Function
0	DIG_OUT_7	digital output 7
1	DIG_OUT_8	digital output 8
2	DIG_OUT_1	FANS ON CMD
3	DIG_OUT_2	FIELD ON CMD
4	DIG_OUT_3	MAIN CONT ON CMD
5..7	reserved	(reserved)
8	DRIVE_DIR	0: drive direction positive 1: drive direction negative see note 1
9	SPEED_EXT	0: torque reference according to min/max evaluation in torque selector modes 4 and 5 1: force speed controller output according in torque selector modes 4 and 5
10 to 15	reserved	(reserved)

**Note 1:** Changes of the commanded drive direction get active only in the state RDY\_RUN; reversal of a running drive by means of this control bit is not possible.  
**Note 2:** Settings for DO1...DO3 are default.

Table 3.8/3: Auxiliary Control Word 2

Main Status Word (8.01)		
Bit	Name	Function
0	RDY_ON	ready to close the contactor
1	RDY_RUN	ready to generate torque
2	RDY_REF	torque control operating (running)
3	TRIPPED	indication of fault in DCS600 MultiDrive
4	OFF_2_STA_N	1: No OFF2_N active
5	OFF_3_STA_N	1: No OFF3_N active
6	ON_INHIBITED	Switch on inhibited
7	ALARM	indication of alarm in DCS600 MultiDrive
8	AT_SETPOINT	Setpoint/act.value monitoring in the tolerance
9	REMOTE	1:Remote control / 0:Local control
10	ABOVE_LIMIT	speed treshold value (50.10) reached
11	reserved	(reserved)
12	reserved	(reserved)
13	reserved	(reserved)
14	reserved	(reserved)
15	reserved	(reserved)

Table 3.8/4: Main Status Word

Auxiliary Status Word (8.02)		
Bit	Name	Function
0	LOGG_DATA_READY	Contents of data logger is readable
1	OUT_OF_WINDOW	Speed actual value is outside of the defined window
2	EMERG_STOP_CO-AST	Emergency stop function has failed
3	reserved	(reserved)
4	ON_DISABLED	External interlocking ON INHIBIT 1 or ON INHIBIT 2 (ORed digital inputs selected by 15.14 and 15.15 ) prevent the run
5	SYNC_RDY	Position counter synchronous ready status
6	FEX1_ACK	acknowledge of 1st Fex
7	FEX2_ACK	acknowledge of 2nd Fex
8	reserved	(reserved)
9	LIMITING	Drive is limiting, see signal 8.03
10	TORQ_CONTROL	Drive is torque controlled
11	ZERO_SPEED	Motor speed actual is zero
12	EMF-SPEED	EMF speed feedback selected if SPEED FB SEL (50.03) = 1
13	FAULT_OR_ALARM	Fault or alarm of drive
14	DRIVE_DIR_ASW	Negative drive direction active
15	AUTO_RECLOSING	auto reclosing logic activated

Table 3.8/5: Auxiliary Status Word

## Digital inputs/outputs

Depending on the drive modes there are different possibilities for digital inputs and outputs.

Digital Inputs		Armature converter mode	
Input	Signal	use	Description
DI 1	DI 1	configurable →	12.13 ACK Converter fan 12.14 ACK Motor fan 12.15 ACK Main contactor 12.16 Emergency STOP 15.13 electrical disconnect 15.14 ON INHIBIT 1 15.15 ON INHIBIT 2 15.18 ACK DC breaker 15.20 ACK DYN brake 28.18 Klixon (motor 1 trip) 28.25 Klixon (motor 2 trip)
DI 2	DI 2		
DI 3	DI 3		
DI 4	DI 4		
DI 5	DI 5		
DI 6	DI 6		
DI 7	DI 7		
DI 8	DI 8		
if COMMAND SEL 15.22 = 1 (local I/O) then DI 6 = Reset; DI 7 = ON; DI 8 = RUN			

Table 3.8/6: Digital inputs Armature converter mode (**DCS 600**)

Digital Inputs		Field converter mode	
Input	Signal	use	Description
DI 2	ACK_OVERVOLT	fix	Acknowledge overvoltage protection DCF 505/506
DI 1	DI 1	configurable →	12.13 ACK Converter fan 12.14 ACK Motor fan 12.15 ACK Main contactor 12.16 Emergency STOP 15.13 electrical disconnect 15.14 ON INHIBIT 1 15.15 ON INHIBIT 2 15.18 ACK DC breaker 15.20 ACK DYN brake 28.18 Klixon (motor 1 trip) 28.25 Klixon (motor 2 trip)
DI 3	DI 3		
DI 4	DI 4		
DI 5	DI 5		
DI 6	DI 6		
DI 7	DI 7		
DI 8	DI 8		
if COMMAND SEL 15.22 = 1 (local I/O) then DI 6 = Reset; DI 7 = ON; DI 8 = RUN			
<b>Note:</b> Do not select DI 2 for these functions!			

Table 3.8/7: Digital inputs Field converter mode (**DCF 600**)

Digital Outputs		Armature converter mode	
Output	Signal	use	Description
DO 1	DIG_OUT 1	configurable →	free / program. by 12.02 default: FANS ON CMD
DO 2	DIG_OUT 2		free / program. by 12.05 default: FIELD ON CMD
DO 3	DIG_OUT 3		free / program. by 12.08 default: MAIN CONT ON CMD
DO 4	DIG_OUT 4		free / program. by 14.10
DO 5	DIG_OUT 5		free / program. by 14.13
DO 6	DIG_OUT 6		free / program. by 14.16
DO 7	DIG_OUT 7		free / program. by 14.19
DO 8	DIG_OUT 8		free / program. by 14.22 e.g. MAIN_CONT_ON_CMD 14.22 = 605 14.23 = 6

Table 3.8/8: Digital outputs Armature converter mode (**DCS600**)

Digital Outputs		Field converter mode	
Output	Signal	use	Description
DO 1	DIG_OUT 1	configurable →	free / program. by 12.02 default: FANS ON CMD
DO 2	DIG_OUT 2		free / program. by 12.05 default: FIELD ON CMD
DO 3	DIG_OUT 3		free / program. by 12.08 default: MAIN CONT ON CMD
DO 4	DIG_OUT 4		free / program. by 14.10
DO 5	DIG_OUT 5		free / program. by 14.13
DO 6	DIG_OUT 6		free / program. by 14.16
DO 7	DIG_OUT 7		free / program. by 14.19
DO 8	DIG_OUT 8		free / program. by 14.22 e.g. MAIN_CONT_ON_CMD 14.22 = 605 14.23 = 6

Table 3.8/9: Digital outputs Field converter mode (**DCF600**)

### Analogue inputs

Depending on the drive modes there are different possibilities for analogue inputs.

Analogue Inputs		Armature converter mode			
Channel	Channel used for signal through:				
	AITAC	AI1	AI2	AI3	AI4
Accuracy	± 4096	± 4096	± 2048	± 2048	± 2048
<b>Signal</b>					
TORQUE CORRECTION		AI1_VAL_SEL 13.16=1			
SPEED REFERENCE	AI SPEED SELECT 13.17=5	AI SPEED SELECT 13.17=1	AI SPEED SELECT 13.17=2	AI SPEED SELECT 13.17=3	AI SPEED SELECT 13.17=4
ACK.EXT.FIELD EXCITER	FEXC_SEL 15.05=9	FEXC_SEL 15.05=10	FEXC_SEL 15.05=11	FEXC_SEL 15.05=12	FEXC_SEL 15.05=13
MOT.1 TEMP. MEASUREMENT			MOT1_TEMP_AI_SEL 28.09=1...5		
MOT.2 TEMP. MEASUREMENT				MOT2_TEMP_AI_SEL 28.12=1...5	
EARTH FAULT MONITORING					EARTH_CUR_FLT_SEL 28.19=1
SPEED MEASUREMENT	SPEED_MEAS_MODE 50.03=4				

Table 3.8/10: Analogue inputs Armature converter mode (DCS600)

# 4 Connection examples

## 4.1 Armature current converter DCS 600

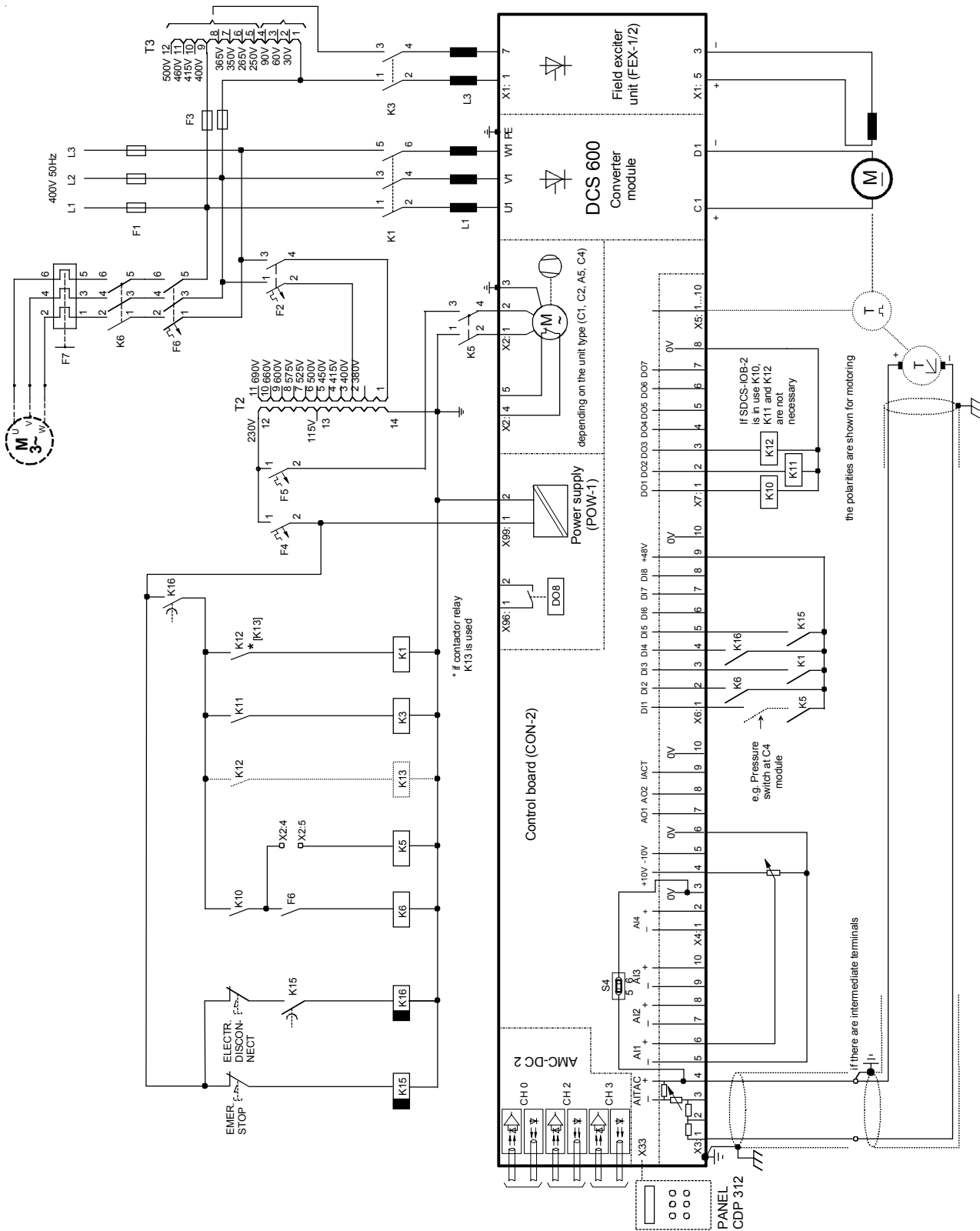

Fig. 4.1/1: DCS 600 Armature current converter wiring diagram

## 4.2 Field supply converter DCF 600

**Note:** In case the supply voltage for the excitation is switched on the primary side of its supply transformer additional overvoltage protection is required. Please contact ABB!

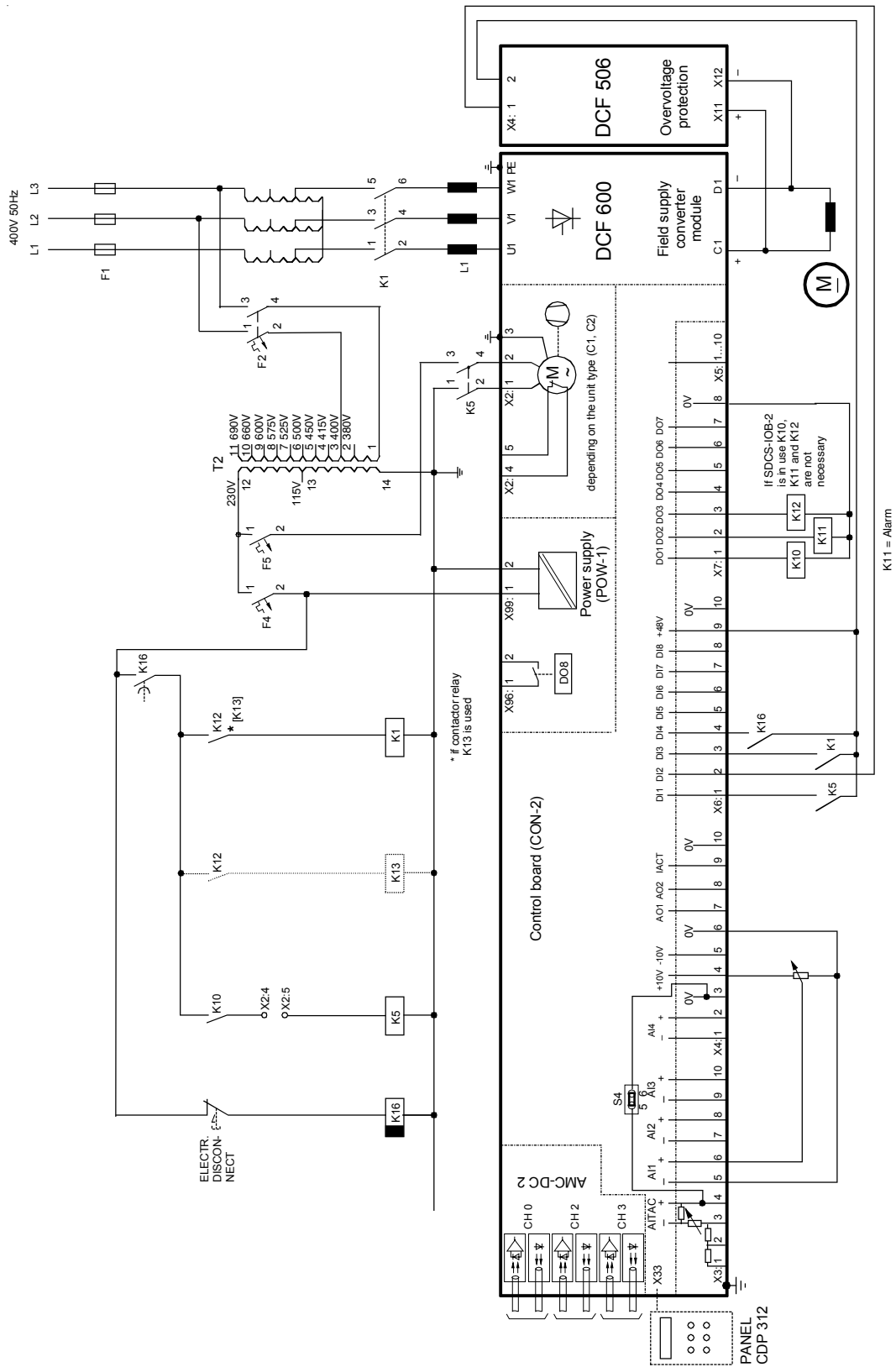

Fig. 4.2/1: DCF 600 Field supply converter wiring diagram

II F 4-2

# Notes



## DC Drives Product Portfolio

### DCS 400

The drive module for standard applications

- Integrated field supply (max. 20 A)
- Accurate speed and torque control
- Extremely small and compact design
- Very easy installation and commissioning
- Express delivery
- Power range: 10...500 kW (13...670 HP)



### DCS 500B / DCS 600

The drive module for demanding applications

- Free programming of software
- 6- and 12-pulse configuration up to 10 MW/13,000 HP and more
- Plain text display
- Power range: 10...5000 kW (13...6700 HP)



### DCE 400 plus

Highly integrated panel

- Extremely small and compact design
- Contains:
  - DCS 400 module
  - AC fuses
  - Auxiliary transformer
  - Motor fan starter with protection
  - Main contactor
- Power range: 20...130 kW (26...174 HP)



### DCS 400 / DCS 500 Easy Drive

The complete standard cabinet solution

- Pre-engineered
- Easy installation and commissioning
- Protection class: IP 21
- Plain text display
- Short delivery time
- Power range: 50...1350 kW (65...1800 HP)



### DCA 500 / DCA 600

For complex, completely engineered Drive System in common cabinet design

- Flexible and modular hardware structure
- 6- and 12-pulse configuration up to 18 MW/23,000 HP and more
- Pre-programmed applications: Metals, Cranes, P&P application, Mining
- Power range: 10...18000 kW (13...23000 HP)



ABB Automation Products GmbH

Postfach 1180

68619 Lampertheim • GERMANY

Telefon +49(0) 62 06 5 03-0

Telefax +49(0) 62 06 5 03-6 09

www.abb.com/dc

Since we aim to always meet the latest state-of-the-art standards with our products, we are sure you will understand when we reserve the right to alter particulars of design, figures, sizes, weights, etc. for our equipment as specified in this brochure.



\*072R0501A4080000\*